



Welcome to the Campo "Field Assist Troubleshooting Guides".

These guides were developed to assist the working technicians in the field. We've supplied issues and solutions to the most common problems encountered in the field. If you need assistance while troubleshooting on the job, they are easy to store in your smart phone, tablet or computer.

Getting Started is easy Just click on 'Page #' for information or the issue you are encountering

- Burner control is locked-out on reset... [Page 2](#)
- Burner control is NOT locked-out on reset... [Page 17](#)
- Technical information... [Page 33](#)
- Pre-season maintenance... [Page 56](#)
- Tech Tips and Bulletins... [Page 52](#)
- Contact US... [Page 55](#)
- To receive Field Assist Troubleshooting Guides... [Page 54](#)



Reset Button

Before resetting the burner control, ensure ...

1. ...there is between **7-14"** WC pressure supplied to the gas valve.
2. ...the 'switchover valve' is in the proper position for **LP OR NG**
3. ...the high-pressure gas switch is **not off** on reset

➤ **NOTE:** If the red status light is flashing rapidly (three time per second) the control is locked out on reset. To reset, push and release the reset button. (red flashing light)

➤ **Warning!** Continuous resetting of the burner control may cause an accumulation of gas in the heatexchanger, and this could lead to an Implosion of the heatexchanger or personal harm.

➤ Proceed to....[Page 3](#)



Choose the issue you are encountering and click on the Page

- You reset the control and it goes through the 60 second purge, but doesn't ignite.....
[Page 4](#)
- You Reset the burner Control, The Burner **motor Did Not Start** and Locks-out on Reset...[Page 13](#)
- You Reset the Burner Control, but the reset light is solid red during the pre-purge, and the control locks out on reset... [Page 15](#)
- You Reset the Burner Control and after the purge, the burner fires up , but the flame goes out after 5 to 10 seconds... [Page 16](#)

You reset the control and it goes through the 60 second purge, but doesn't ignite...



- Install your manometer in the **outlet** port of the manual valve between the gas valve and **LP/NG** switchover valve.
- Reset the burner control.
- After the **60** second purge, check to see if gas pressure is coming through the valve.
- Keep a close eye on the manometer, as the pressure will only register for 1 second after the **60** second pre-purge.

- If gas pressure **is** present... [Page 5](#)

- If gas pressure is **NOT** present... [Page 9](#)

[HOME](#)

Outlet Port





- ✓ Defective burner control
- ✓ Defective ignition cable
- ✓ Broken ignition electrode
- ✓ Defective igniter



➤ Test the components... [Page 6](#)



SHUT OFF the gas supply to the burner before testing!

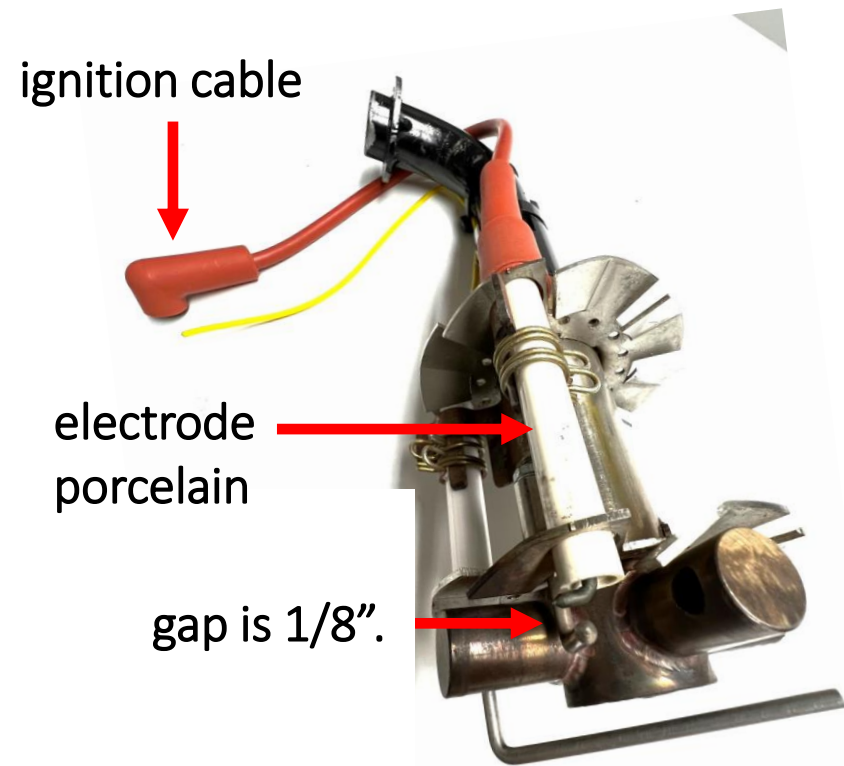

Remove the burner gun from the burner housing.

- Inspect the ignition cable for cracks.
 - Inspect the ignition electrode porcelain for cracks.
 - Inspect the electrode gap, ensuring the gap is 1/8".
- ✓ Replace damaged pieces as appropriate.
- Testing the ignitor for spark...[Page 7](#)



- With the gun still outside the burner casing, re-connect the ignition cable to the igniter and restore power to the burner.
 - Ensure the gun is **WELL GROUNDED** to the burner housing when testing for spark.
 - Reset the burner control and check for spark after the purge.
 - Keep a close eye on the electrode as the spark will only appear for 1 or 2 seconds AFTER the 60 second purge.
- **NO spark** indicates...Defective burner control, or Defective igniter
- Testing the components...[Page 8](#)

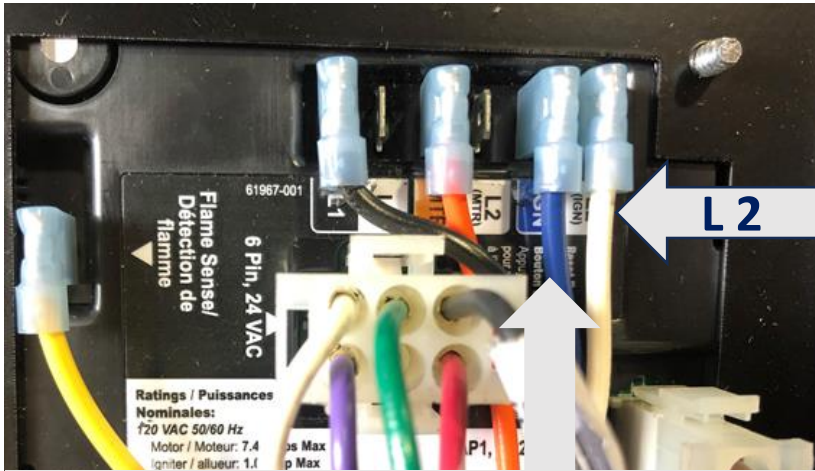

Blue wire ignition terminal

- Reset burner control. After the 60 second purge, check for **120 volts** on terminal 'IGN' and L2
 - ✓ If **120 volts** is **NOT** present after the 60 second purge, Defective burner control
 - ✓ If **120 volts** **is** present, defective igniter

Problem Solved



- ✓ Defective **24 volts** transformer
- ✓ Defective burner control
- ✓ Defective (one of the two) gas valve(s)



➤ Test the components... [Page 10](#)

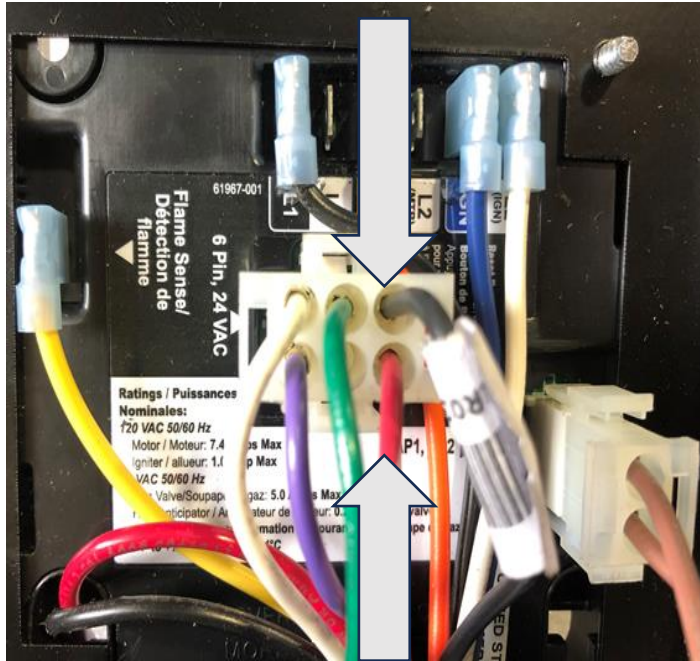

Check for **24 volts** on black and red stripe wires on 6 prong plug.

✓ If **24 volts** is **NOT** present, the transformer is defective.

• If **24 volts** is present... [Page 11](#)

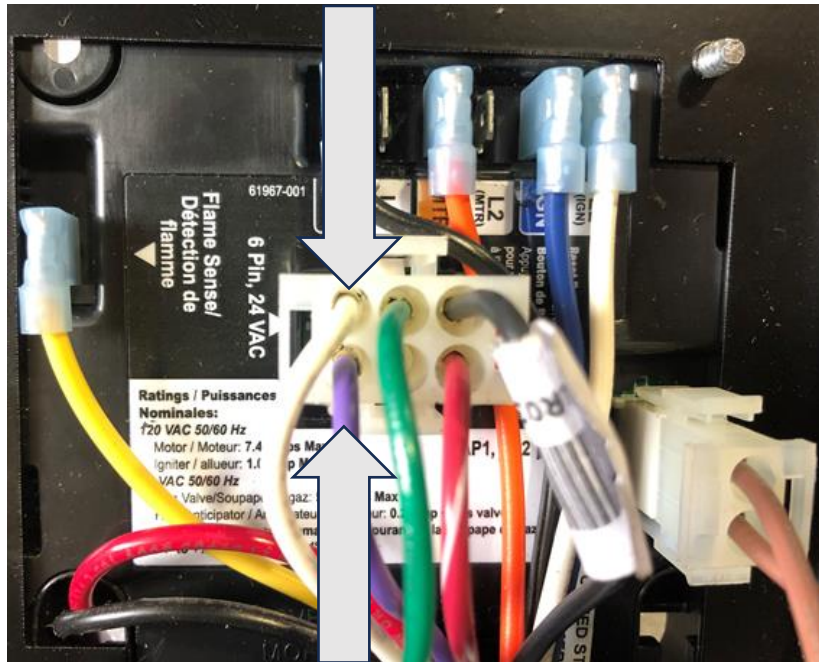

Reset the Burner Control. After the 60 second purge, check for **24 volts** on the white and violet wires on the 6-prong plug.

- ✓ If **24 volts** is **NOT** present after the purge, the burner control is defective.
- If **24 volts** **is** present after the 60 second purge, ONE of the two gas valves is defective, continue checking gas valves... [Page12](#)

Checking the gas solenoid valves when 24 volts is present on the burner control...

“Field Assist Troubleshooting Guide”



Gas valve #1

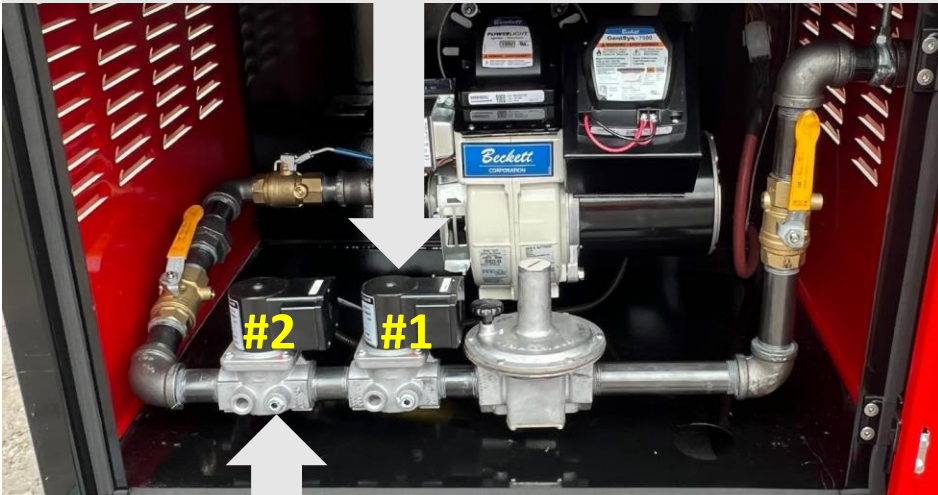

Gas valve #2 test port

- Install manometer in gas valve #2 test port. Reset the Burner Control and check for gas pressure after the 60 second purge...
- **NOTE:** Keep a close eye on the manometer, as the pressure will only register for 1 or 2 seconds after the 60 second pre-purge.)
- ✓ If **NO** pressure is detected, the #1 valve is defective.
- ✓ If pressure **IS** detected, #2 valve is defective.

You reset the control. The motor did not start, and the control locks-out on safety.



Light Flashing reset control

✓ Defective burner motor.



✓ Defective Burner Control



✓ Defective R3 relay



➤ Test the components...[Page 14](#)

Checking burner motor, motor relay, and burner control



➤ Make sure the burner motor reset is **not** locked out.

- Reset burner control, then check for **120 volts** at R3 relay wire **#15G**

R3 wire #19

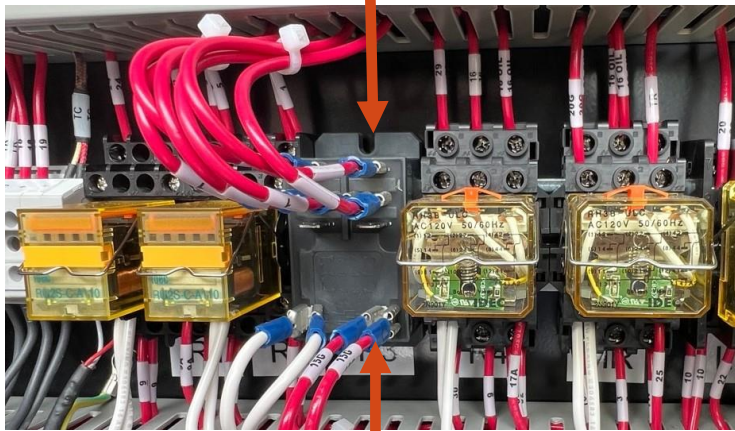

- ✓ If **120 volts** is **NOT** present, defective burner control.
- If **120 volts** is present, check for **120 volts** on R3 relay **# 19**
- ✓ If **120 volts** is **NOT** present, defective relay R3
- ✓ If **120 volts** is present, defective burner motor

[HOME](#)

R3 wire #15G

Problem Solved

You reset the burner control, but the reset light is solid red during the purge, and the control locks out on reset...

“Field Assist Troubleshooting Guide”



air proven switch

- **Note:** The air proven switch contact must be open to start and close after the burner motor starts.
- ✓ The air proving switch is defective
- ✓ The air hose is cracked or busted

Problem Solved

You reset the burner control and after the purge, the burner fires up, but the flame goes out after 5 or 10 seconds.

“Field Assist Troubleshooting Guide”



- Clean or replace flame rod and wire.
 - ✓ Flame rod lead wire is defective
 - ✓ The flame rod is defective or dirty
 - ✓ If the flame rod and wire are good then the control is suspect.
- **NOTE:** do not use sandpaper to clean flame rod. A cloth will be sufficient.

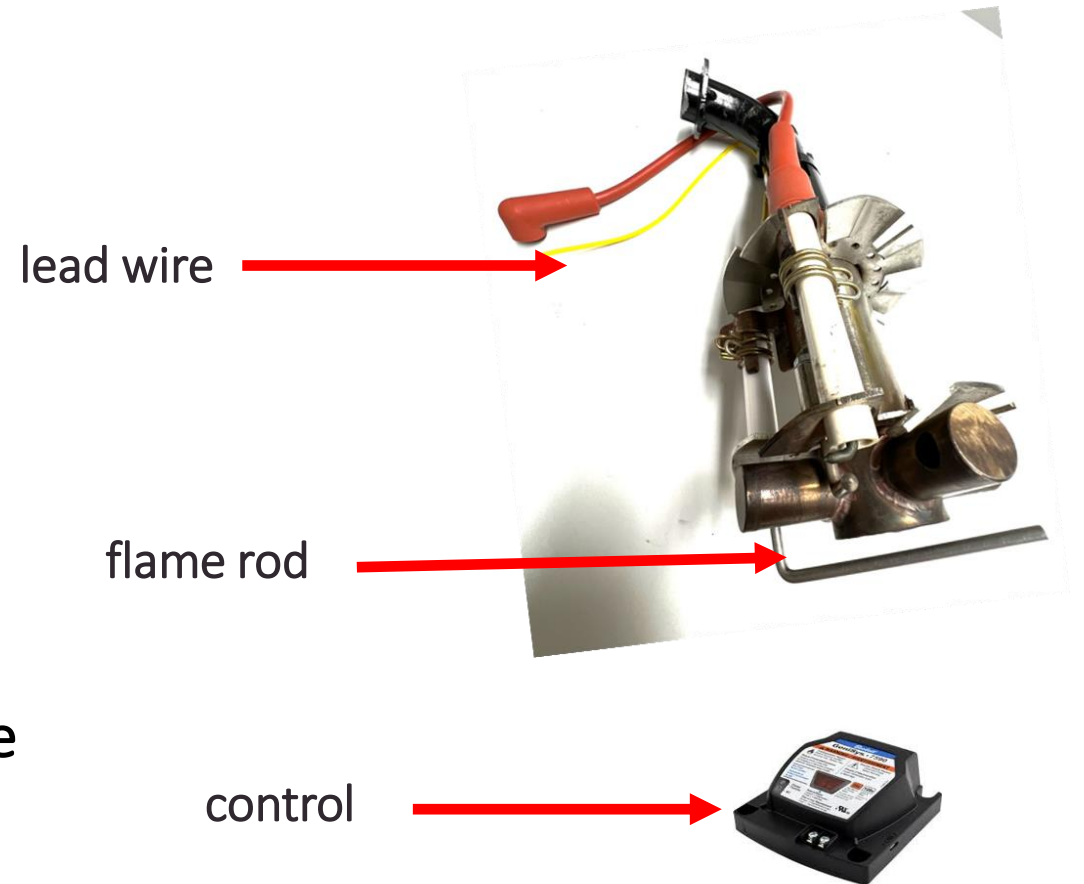

Problem Solved



Choose the issue you are encountering and click on the Page #

- If The Burner Control Is NOT Locked Out On Reset And Will Not Start... [Page 18](#)
- If the 'overheat reset' light is illuminated and will not reset... [Page 26](#)
- If The circulating Fan Fails To Start... [Page 28](#)
- If the circulating Fan Does Not Shut Off... [Page 31](#)



➤ Before Proceeding, It is **important** to check voltage from Line L1 and L2, “**Not**” to ground.

- Turn the main power switch is in the **ON** position
- Turn the ‘gas/oil switch’ to the **gas position**
- Turn the ‘controls’ switch to the **ON** position
- Turn the bypass toggle switch to **on.**
- Turn the Heat/off/Fan switch to **on** heat
- Check the high-pressure gas switch on the gas train to be sure it is **NOT** off on reset.



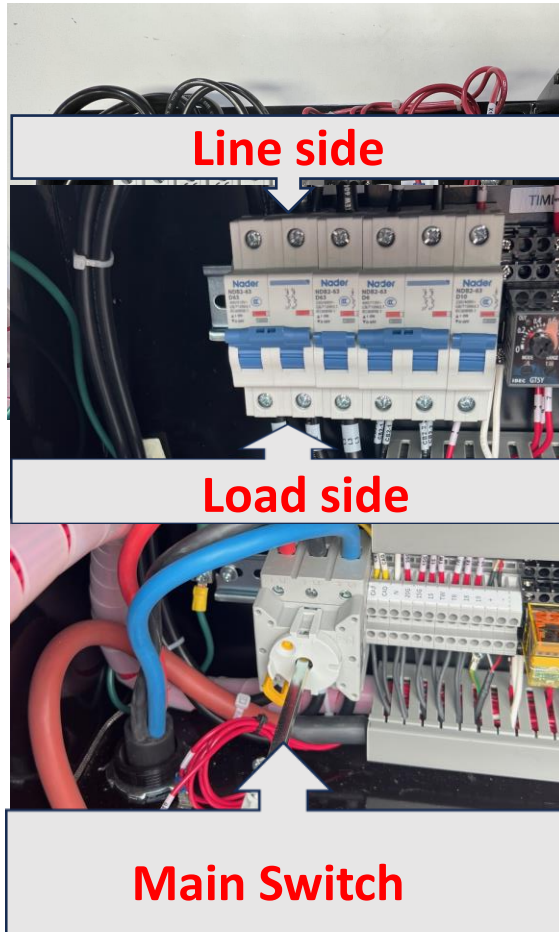

- Check for **208 to 240 volts** on the Top of the “Main Switch”.
- ✓ If **no** voltage present on top of main switch, power supply issue.

- Check for **208 to 240 volts** on CB3 Line side between L1 and L2.
- ✓ If **no** voltage between L1 and L2 line side, defective switch.
- If **208 to 240 volts is** present, check for **208 to 240 volts** on CB3 Load side between L1 and L2
- ✓ If **208 to 240 volts is not** present, breaker is off or defective.
- If **208 to 240 volts is** present, check for **208 to 240 volts** between L1 and L2 on CB2 load side.
- ✓ If **208 to 240 volts is NOT** present, defective breaker or tripped off.

➤ Continue to... [Page 20](#)

If the burner control is NOT locked out on reset and will not start...

“Field Assist Troubleshooting Guide”

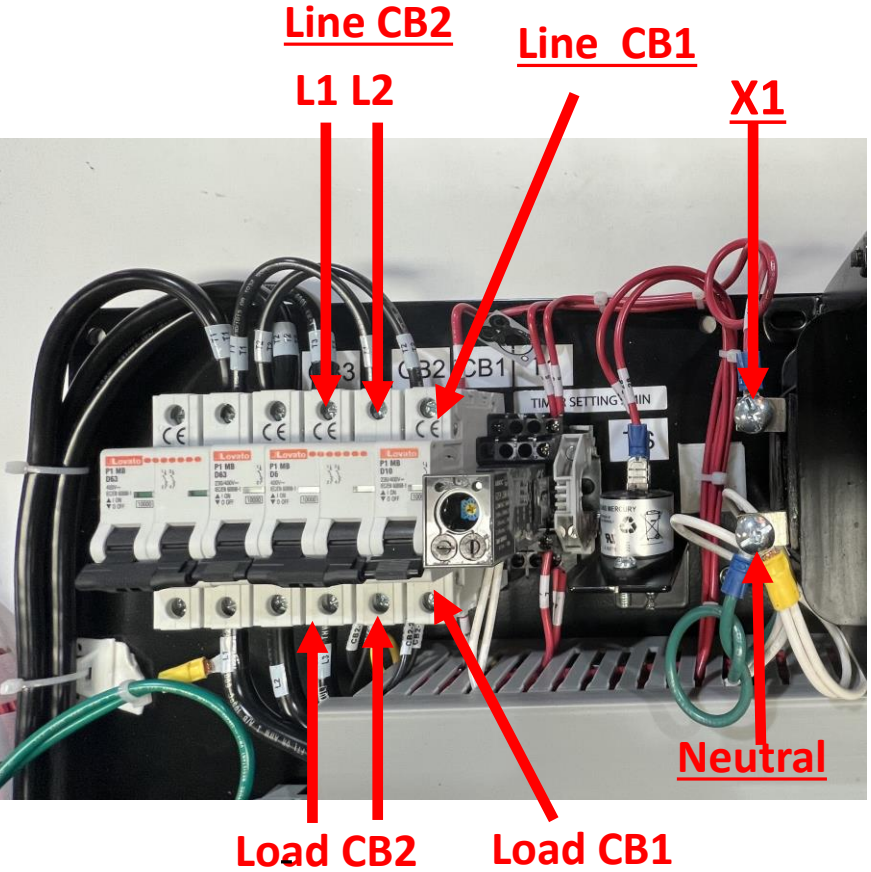

- Check for 120 volts on CB1 line side and Neutral
- ✓ If 120 volts is Not present, defective transformer.
- If 120 volts is present, check for 120 volts on CB1 Load side and Neutral.
- ✓ If 120 volts is NOT present, defective breaker or tripped off.

Continue...[Page 21](#)

If the burner control is NOT locked out on reset and will not start...

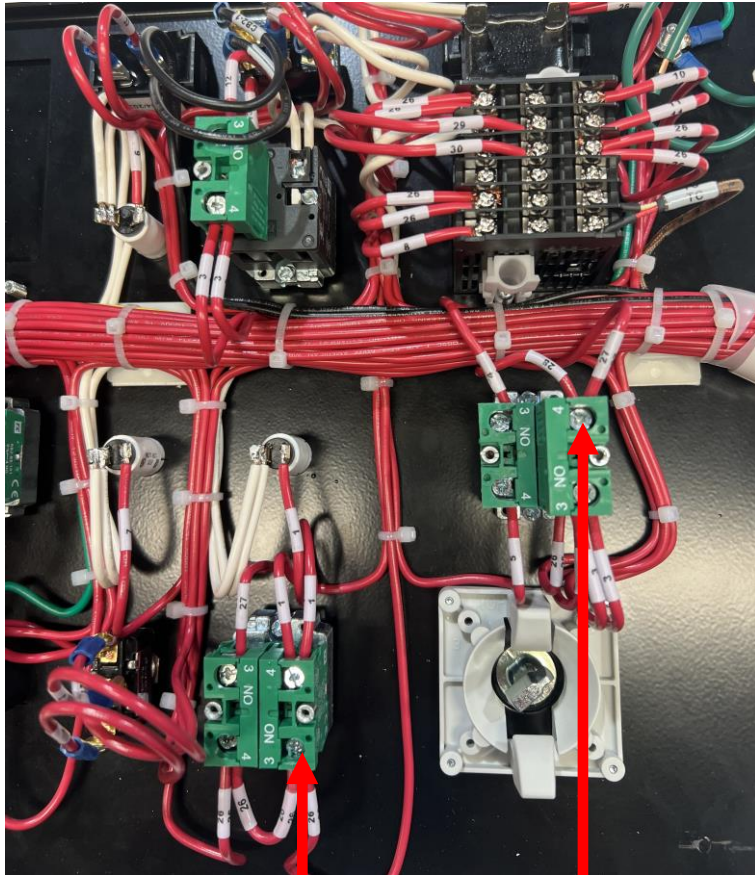

#26

#28

- Check for **120 volts** at ‘control switch’ wire **#26**
- If **120 volts** is **NOT** present, defective switch.
- If **120 volts** **is** present, check for **120 volts** on ‘Heat/Fan switch’ wire **#28**
- If **120 volts** is **NOT** present, defective ‘Heat/Fan switch.
- If **120 volts** **is** present... [Page 22](#)

If the burner control is NOT locked out on reset and will not start...



Tilt SW
#22

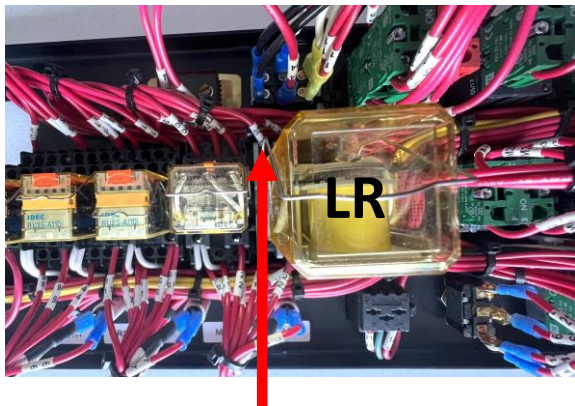
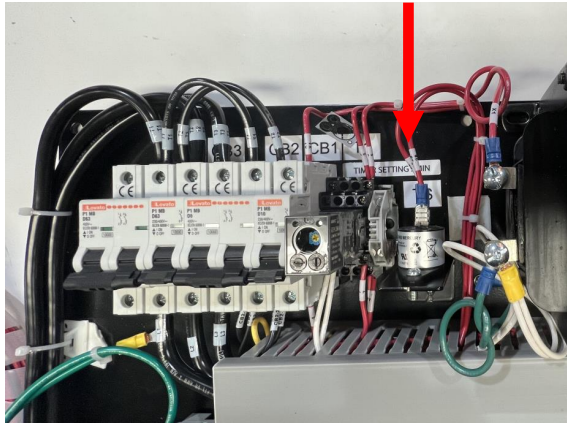

LR #20G

- Check for 120 volts on ‘tilt switch’ wire #22.
- ✓ If 120 volts is NOT present, defective ‘tilt switch’
- If 120 volts is present, check for 120 volts at LR relay wire #20G
- ✓ If 120 volts is NOT present, defective LR relay.
- If 120 volts is present...[Page 23](#)

If the burner control is NOT locked out on reset and will not start...



R1 #24

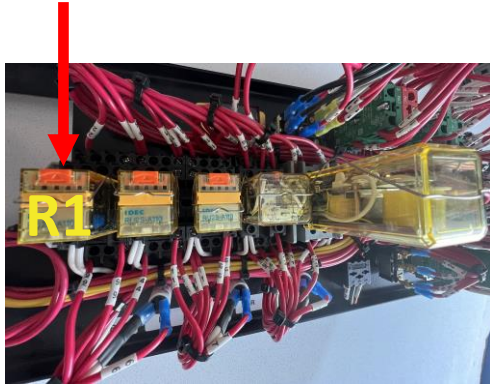

- Check for **120 volts** on R1 relay wire **#24**
- If **120 volts** is **NOT** present, defective fan motor thermostat.

➤ **Note:** the fan motor thermostat is located **inside** the fan motor and is **not** field serviceable.

- ✓ Have the motor sent to a motor repair shop to replace the thermostat or replace with a new fan.

➤ If **120 volts** is present...[Page 24](#)

If the burner control is NOT locked out on reset and will not start...

“Field Assist Troubleshooting Guide”

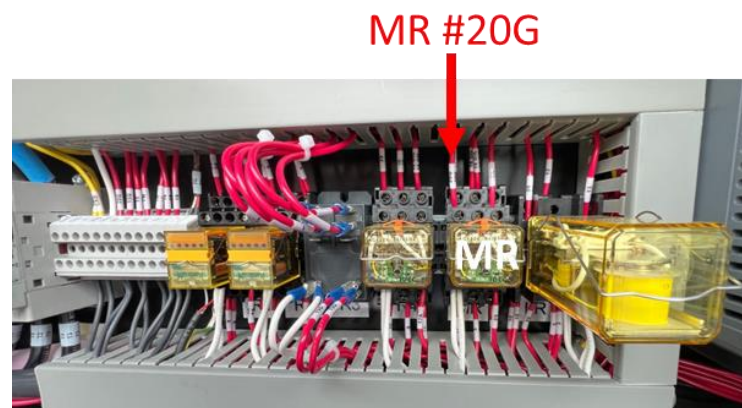
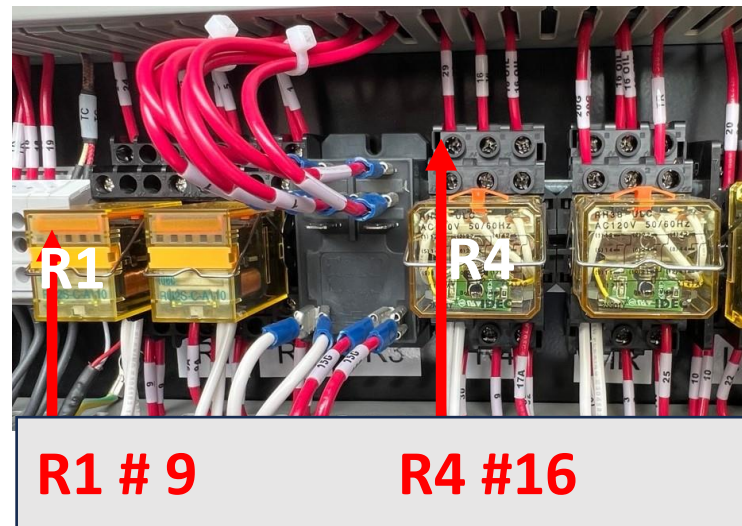

- If 120 volts is present, check for 120 volts at R1 wire #9
- ✓ If 120 volts is NOT present, defective R1 relay.

- If 120 volts is present, check for 120 volts at R4 wire #16
- ✓ If 120 volts is NOT present, defective R4 relay.

- If 120 volts is present, check for 120 volts at MR wire #20G
- If 120 volts is NOT present, defective MR relay.

Problem Solved

For future use

“Field Assist Troubleshooting Guide”



[HOME](#)



If the 'overheat reset' light is illuminated and will not reset...

"Field Assist Troubleshooting Guide"

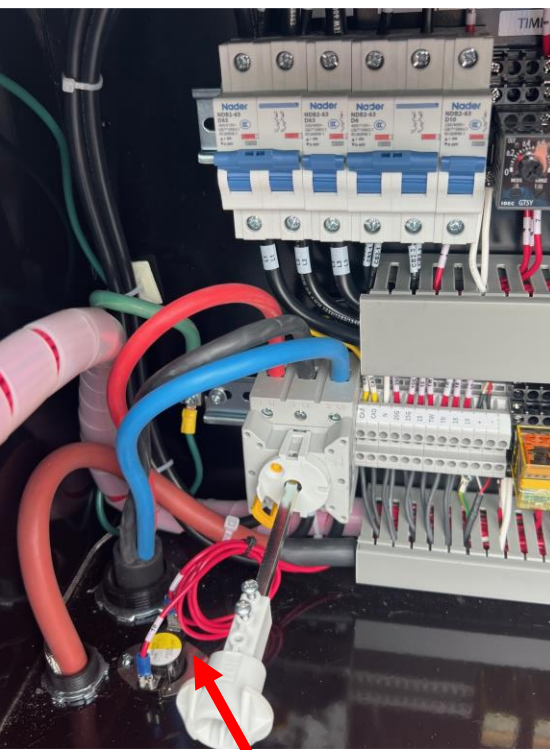

#10
150°F thermal limit disc

Check for **120 volts** on wire **#10** on the 150°F thermal limit disc
If **120 volts** is present...

- ✓ Defective 150°F thermal limit disc
- ✓ Defective LR Relay
- ✓ Defective temperature controller
- ✓ Defective thermocouple



➤ Testing the components... [Page 27](#)

If the 'overheat reset' light is illuminated and will not reset...Testing the 150°F thermal limit disc

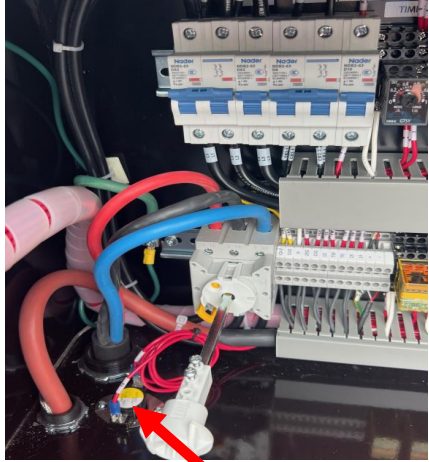

150°F disc #10

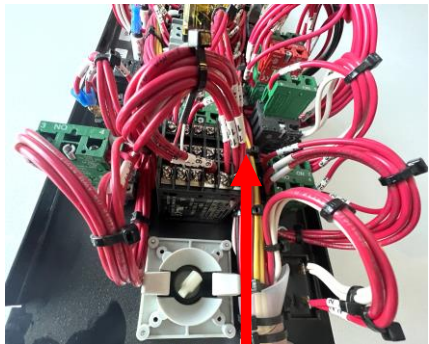

Wire #10

Temperature controller

Turn off power to the heater. Remove wire #10 from the 150°F thermal limit disc. Restore power to the heater. Reset the 'overheat reset' button. If the burner starts, the 150°F thermal limit disc is defective.

If the overheat reset still stays illuminated. Turn off power to the heater. Remove the #10 wire from the temperature controller. Restore power to the heater. Reset the 'overheat reset' button.

If the burner starts, the temperature controller is defective.

If the 'overheat reset' remains illuminated, the LR relay is defective.

Problem Solved

If the circulating fan does not start...

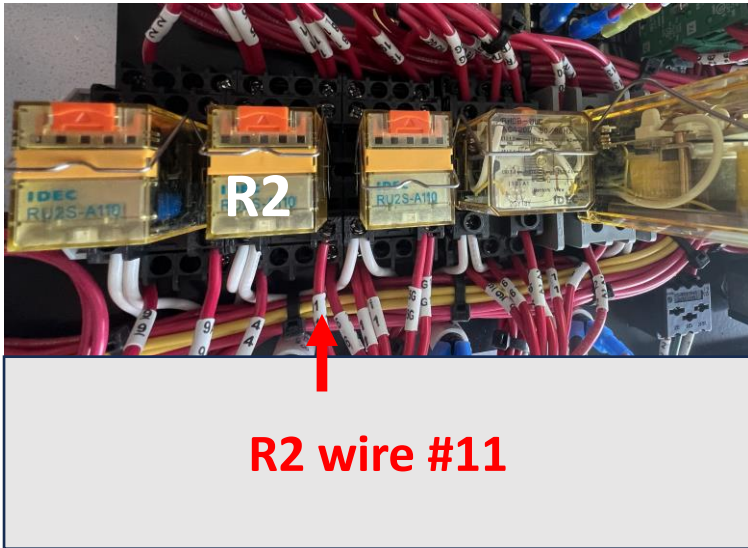

- Check for **120 volts** at R2 relay wire **#11**.
- If **120 volts** is present, defective R2 relay
- If **120 volts** is **NOT** present...



✓ Defective temperature controller.



✓ Defective thermocouple



✓ Defective timer



✓ Defective VFD



✓ Defective Fan speed switch.



[HOME](#)

➤ Check the components... [Page 29](#)

If the circulating fan does not start...



- **Note:** The heater is equipped with multiple switches to insure positive start of the circulating fan. It is very unlikely that all switches would be defective.



Testing temperature controller. When the display temperature reaches **90° F** check for **120 volts** on wire **# 11** on temperature controller.

✓ If no voltage present, defective temperature controller.



Testing thermocouple. If the display reads odd numbers...[Page 52](#)



Testing the fan timer. After the burner has run for **2 minutes**, place a jumper between **#4** and **#5** wires. If the fan starts, defective timer.

Testing the fan speed switch. Place a jumper between **#M1** and **#M3** wires on the back of the switch. If the fan starts, defective speed switch.

[HOME](#)

- If the fan doesn't start, check the VFD...[Page 30](#)

If the circulating fan fails to start or not stop Testing the VFD (Variable Frequency Drive)

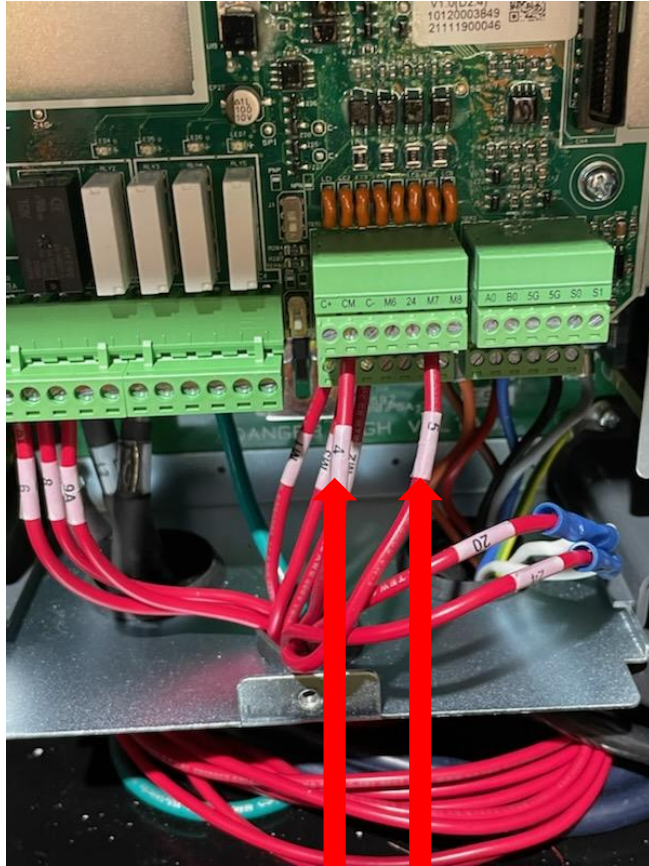

Make sure **208 to 240 volts** is being supplied to the VFD

1. Turn off power to the heater.
 2. Remove the cover of the VFD.
 3. Ensure that all wires are secured to the terminals.
 4. Ensure the terminal blocks are secured properly into place.
 5. Restore power to the heater.
 6. Place a jumper between CM **#4** wire and M7 **#5** wire.
- ✓ If the fan doesn't Start the VFD is Defective

- If fan doesn't stop running, remove wire **#4**
- ✓ If the fan stops the VFD is Defective

HOME

#4 #5

Problem Solved

If the circulating fan does not shut off automatically...



R2 wire #11

➤ Check the components... [Page 32](#)

- Check for 120 volts at R2 relay wire #11.
- ✓ If 120 volts is **Not** present, defective R2 relay
- If 120 volts **is** present...



- ✓ Defective temperature controller.



- ✓ Defective thermocouple



- ✓ Defective timer



- ✓ Defective VFD



- ✓ Defective fan switch



[HOME](#)

If the circulating fan does not shut off automatically...



- Testing temperature controller. with the display temperature under 80° F check for 120 volts on terminal wire #11
- ✓ If 120 volts is present, defective temperature controller.



- Testing thermocouple. If the display reads odd numbers....[Page 52](#)



- Testing the fan timer. With the burner not running, check for 120 volts on terminal wire #4 and #5
- ✓ If 120 volts is present, defective fan timer.
- ✓ If 120 volts is not present, check the VFD...



- Testing the fan speed switch. Remove wire #M1 on the back of the switch. If the fan stops, defective speed switch.

➤ Checking the VFD...[Page 30](#)



Choose the information you are looking for and click on the Page #

- Set-up guides...[Page 34](#)
- Start-up procedure...[Page 43](#)
- Electrical hook up...[Page 37](#)
- Gas Piping charts...[Page 38](#)
- Venting the heater...[Page 35](#)
- Gas pressures...[Page 44](#)
- Example regulator sizing and pipe sizing...[Page 58](#)
- Adjusting the burner combustion...[Page 48](#)
- Gas train test ports and adjustment locations...[Page 50](#)
- Ducting limitations...[Page 51](#)
- Pre-season maintenance...[Page 56](#)
- [Air adjustments...Page 49](#)



1

The heater should be installed level, and on solid ground or base.

2

The heater should be installed on a noncombustible base (material).

3

The heater should not be installed in an area where combustible gases are circulating.

4

The heater must be equipped with vent (flue) pipes installed. See venting...[Page 35](#)

5

The heater should have the proper size wiring for voltage and amperage demand...[Page 37](#)

6

All gas piping and wiring cables should be routed so they are protected from water or traffic.

7

Ensure all piping and fittings are free from gas leaks.

8

Ensure proper ducting of heater respecting limitations...[Page 51](#)

[HOME](#)

Continue start-up...[Page 43](#)

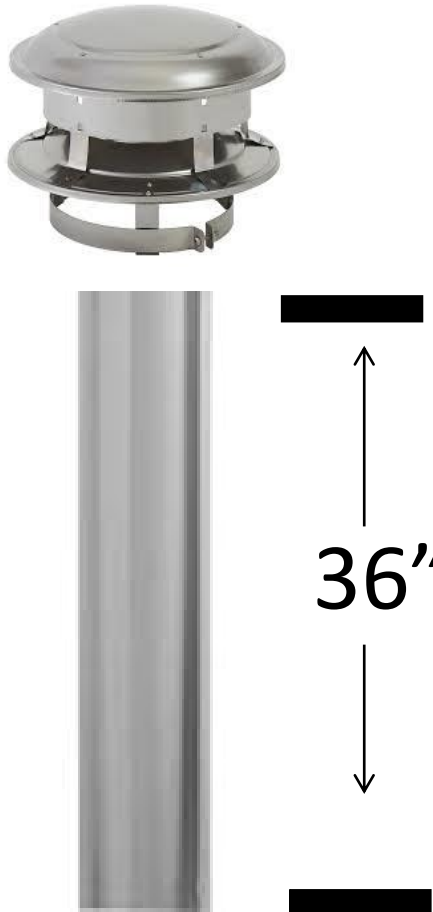

- Make sure to install a stack minimum 30” on the flue.
- Make sure to install a rain cap on the flue pipe.
- Make sure that flue gases are not being recirculated into the blower fan and pushed into the space you are heating.

WARNING: The appropriate measures must be taken to ensure there will be no positive pressures on the exhaust flue of the heater.

➤ Venting from inside a building...[Page 36](#)

Best practices for venting when heater is located inside a building

- Avoid using as many 90-degree elbows as possible
- Venting runs should be as short as possible
- Vertical rise minimum 3 feet, 5 feet is better outside the building.
- 20 feet maximum flue run and always install a rain cap.

- Never decrease diameter of flue piping.
- Horizontal runs $\frac{1}{4}$ " per foot rise.
- Make sure all piping is properly secured.
- Make sure there is no negative pressure inside the building where the heater is placed.

➤ **Note:** where the vent pipe passes through a combustible wall a fireproof thimble must be used.





- **All wiring and connections** to the heater should be calculated by a qualified electrician and approved by the local authorities having jurisdiction.

Note: The proper voltage and amperage draw is specified on the rating plate of the heater, failure to comply with electrical standards for wiring and amperage draw of the heater may cause damage to the heater. Consult a qualified electrician for assistance in wire sizing.

- Return to set up procedure... [Page 34](#)
- Back to information menu... [Page 33](#)

Piping charts gas 0.6 specific gravity... “Field Assist Troubleshooting Guide”



1

.05 PSIG. Or
less... [Page 39](#)



2

1 PSIG. With less
than 10 % pressure
drop... [Page 40](#)



3

2 PSIG. With less
than 10 %
pressure drop...
[Page 41](#)



4

5 PSIG. With less
than 10 %
pressure drop...
[Page 42](#)

➤ **Note:** All gas piping should be calculated and installed by a qualified Gas fitter.

Gas fitters have charts for sizing gas pipes and proper regulators for different pressures and installations.

[HOME](#)

➤ Start-up continued... [Page 44](#)

**Maximum Capacity of Pipe in Cubic Feet of Gas per
Hour for Gas Pressures of 0.5 Psig or Less and a
Pressure Drop of 0.3 Inch Water Column
(Based on a 0.60 Specific Gravity Gas)**

| Nominal Iron Pipe Size, Inches | Internal Diameter, Inches | Length of Pipe, Feet | | | | | | | | | | | | | |
|---|---------------------------------|----------------------|-------|-------|-------|-------|-------|-------|-------|-------|-------|-------|-------|-------|-----|
| | | 10 | 20 | 30 | 40 | 50 | 60 | 70 | 80 | 90 | 100 | 125 | 150 | 175 | 200 |
| ¼ | .364 | 32 | 22 | 18 | 15 | 14 | 12 | 11 | 11 | 10 | 9 | 8 | 8 | 7 | 6 |
| ⅜ | .493 | 72 | 49 | 40 | 34 | 30 | 27 | 25 | 23 | 22 | 21 | 18 | 17 | 15 | 14 |
| ½ | .622 | 132 | 92 | 73 | 63 | 56 | 50 | 46 | 43 | 40 | 38 | 34 | 31 | 28 | 26 |
| ¾ | .824 | 278 | 190 | 152 | 130 | 115 | 105 | 96 | 90 | 84 | 79 | 72 | 64 | 59 | 55 |
| 1 | 1.049 | 520 | 350 | 285 | 245 | 215 | 195 | 180 | 170 | 160 | 150 | 130 | 120 | 110 | 100 |
| 1¼ | 1.380 | 1,050 | 730 | 590 | 500 | 440 | 400 | 370 | 350 | 320 | 305 | 275 | 250 | 225 | 210 |
| 1½ | 1.610 | 1,600 | 1,100 | 890 | 760 | 670 | 610 | 560 | 530 | 490 | 460 | 410 | 380 | 350 | 320 |
| 2 | 2.067 | 3,050 | 2,100 | 1,650 | 1,450 | 1,270 | 1,150 | 1,050 | 990 | 930 | 870 | 780 | 710 | 650 | 610 |
| 2½ | 2.469 | 4,800 | 3,300 | 2,700 | 2,300 | 2,000 | 1,850 | 1,700 | 1,600 | 1,500 | 1,400 | 1,250 | 1,130 | 1,050 | 980 |

[HOME](#)

[Return to Chart Menu...](#) **[Page 38](#)**

Pipe Sizing Table for 1 Pound Pressure
Capacity of Pipes of Different Diameters and Lengths in
Cubic Feet per Hour for an Initial Pressure of 1.0 Psig With a
10 Percent Pressure Drop and a Gas of 0.6 Specific Gravity

| Pipe Size of Schedule 40 Standard Pipe (Inches) | Internal Diameter (Inches) | Total Equivalent Length of Pipe in Feet | | | | | | | | | | |
|--|----------------------------------|---|--------|-------|-------|-------|-------|-------|-------|-------|-------|-------|
| | | 50 | 100 | 150 | 200 | 250 | 300 | 400 | 500 | 1000 | 1500 | 2000 |
| 1.00 | 1.049 | 717 | 493 | 396 | 338 | 300 | 272 | 233 | 206 | 142 | 114 | 97 |
| 1.25 | 1.380 | 1471 | 1011 | 812 | 695 | 616 | 558 | 478 | 423 | 291 | 234 | 200 |
| 1.50 | 1.610 | 2204 | 1515 | 1217 | 1041 | 923 | 836 | 716 | 634 | 436 | 350 | 300 |
| 2.00 | 2.067 | 4245 | 2918 | 2343 | 2005 | 1777 | 1610 | 1378 | 1222 | 840 | 674 | 577 |
| 2.50 | 2.469 | 6766 | 4651 | 3735 | 3196 | 2833 | 2567 | 2197 | 1947 | 1338 | 1075 | 920 |
| 3.00 | 3.068 | 11962 | 8221 | 6602 | 5650 | 5008 | 4538 | 3884 | 3442 | 2366 | 1900 | 1626 |
| 3.50 | 3.548 | 17514 | 12037 | 9666 | 8273 | 7332 | 6644 | 5686 | 5039 | 3464 | 2781 | 2381 |
| 4.00 | 4.026 | 24398 | 16769 | 13466 | 11525 | 10214 | 9255 | 7921 | 7020 | 4825 | 3875 | 3316 |
| 5.00 | 5.047 | 44140 | 30337 | 24362 | 20851 | 18479 | 16744 | 14330 | 12701 | 8729 | 7010 | 6000 |
| 6.00 | 6.065 | 71473 | 49123 | 39447 | 33762 | 29923 | 27112 | 23204 | 20566 | 14135 | 11351 | 9715 |
| 8.00 | 7.981 | 146849 | 100929 | 81049 | 69368 | 61479 | 55705 | 47676 | 42254 | 29041 | 23321 | 19960 |

[HOME](#)

[Return to Chart Menu...](#) **[Page 38](#)**

Pipe Sizing Table for 2 Pounds Pressure
Capacity of Pipes of Different Diameters and Lengths in
Cubic Feet per Hour for an Initial Pressure of 2.0 Psig With a
10 Percent Pressure Drop and a Gas of 0.6 Specific Gravity

41

| Pipe Size of Schedule 40 Standard Pipe (Inches) | Internal Diameter (Inches) | Total Equivalent Length of Pipe in Feet | | | | | | | | | | |
|--|----------------------------------|---|--------|--------|--------|-------|-------|-------|-------|-------|-------|-------|
| | | 50 | 100 | 150 | 200 | 250 | 300 | 400 | 500 | 1000 | 1500 | 2000 |
| 1.00 | 1.049 | 1112 | 764 | 614 | 525 | 466 | 422 | 361 | 320 | 220 | 177 | 151 |
| 1.25 | 1.380 | 2283 | 1569 | 1260 | 1079 | 956 | 866 | 741 | 657 | 452 | 363 | 310 |
| 1.50 | 1.610 | 3421 | 2351 | 1888 | 1616 | 1432 | 1298 | 1111 | 984 | 677 | 543 | 465 |
| 2.00 | 2.067 | 6589 | 4528 | 3636 | 3112 | 2758 | 2499 | 2139 | 1896 | 1303 | 1046 | 896 |
| 2.50 | 2.469 | 10501 | 7217 | 5796 | 4961 | 4396 | 3983 | 3409 | 3022 | 2077 | 1668 | 1427 |
| 3.00 | 3.068 | 18564 | 12759 | 10246 | 8769 | 7772 | 7042 | 6027 | 5342 | 3671 | 2948 | 2523 |
| 3.50 | 3.548 | 27181 | 18681 | 15002 | 12840 | 11379 | 10311 | 8825 | 7821 | 5375 | 4317 | 3694 |
| 4.00 | 4.026 | 37865 | 26025 | 20899 | 17887 | 15853 | 14364 | 12293 | 10895 | 7488 | 6013 | 5147 |
| 5.00 | 5.047 | 68504 | 47082 | 37809 | 32359 | 28680 | 25986 | 22240 | 19711 | 13547 | 10879 | 9311 |
| 6.00 | 6.065 | 110924 | 76237 | 61221 | 52397 | 46439 | 42077 | 36012 | 31917 | 21936 | 17616 | 15077 |
| 8.00 | 7.981 | 227906 | 156638 | 125786 | 107657 | 95414 | 86452 | 73992 | 65578 | 45071 | 36194 | 30977 |

Pipe Sizing Table for 5 Pounds Pressure
Capacity of Pipes of Different Diameters and Lengths in
Cubic Feet per Hour for an Initial Pressure of 5.0 Psig With a
10 Percent Pressure Drop and a Gas of 0.6 Specific Gravity

42

| Pipe Size of Schedule 40 Standard Pipe (Inches) | Internal Diameter (Inches) | Total Equivalent Length of Pipe in Feet | | | | | | | | | | |
|--|----------------------------------|---|--------|--------|--------|--------|--------|--------|--------|-------|-------|-------|
| | | 50 | 100 | 150 | 200 | 250 | 300 | 400 | 500 | 1000 | 1500 | 2000 |
| 1.00 | 1.049 | 1989 | 1367 | 1098 | 940 | 833 | 755 | 646 | 572 | 393 | 316 | 270 |
| 1.25 | 1.380 | 4084 | 2807 | 2254 | 1929 | 1710 | 1549 | 1326 | 1175 | 808 | 649 | 555 |
| 1.50 | 1.610 | 6120 | 4206 | 3378 | 2891 | 2562 | 2321 | 1987 | 1761 | 1210 | 972 | 832 |
| 2.00 | 2.067 | 11786 | 8104 | 6505 | 5567 | 4934 | 4471 | 3827 | 3391 | 2331 | 1872 | 1602 |
| 2.50 | 2.469 | 18785 | 12914 | 10368 | 8874 | 7865 | 7126 | 6099 | 5405 | 3715 | 2983 | 2553 |
| 3.00 | 3.068 | 33209 | 22824 | 18329 | 15687 | 13903 | 12597 | 10782 | 9556 | 6568 | 5274 | 4514 |
| 3.50 | 3.548 | 48623 | 33418 | 26836 | 22968 | 20356 | 18444 | 15786 | 13991 | 9616 | 7722 | 6609 |
| 4.00 | 4.026 | 67736 | 46555 | 37385 | 31997 | 28358 | 25694 | 21991 | 19490 | 13396 | 10757 | 9207 |
| 5.00 | 5.047 | 122544 | 84224 | 67635 | 57887 | 51304 | 46485 | 39785 | 35261 | 24235 | 19461 | 16656 |
| 6.00 | 6.065 | 198427 | 136378 | 109516 | 93732 | 83073 | 75270 | 64421 | 57095 | 39241 | 31512 | 26970 |
| 8.00 | 7.981 | 407692 | 280204 | 225014 | 192583 | 170683 | 154651 | 132361 | 117309 | 80626 | 64745 | 55614 |

[HOME](#)

[Return to Chart Menu...](#) [Page 38](#)



1

All heaters should be set up by a **qualified** gas fitter.



2

Make sure all piping and fittings are tight and free from gas leaks.



3

Purge all air from gas lines connected to the regulator.



4

Ensure all gas regulators are properly calculated for the burner pressure input and output.

- **Note:** If the heater is going to be **connected to a generator**, always have the heater shut off until the generator is operating steady and voltage is correct. Ensure the generator is properly **sized** to accommodate the heater voltage and amperage draw.

[HOME](#)

➤ Start-up continued...[Page 44](#)

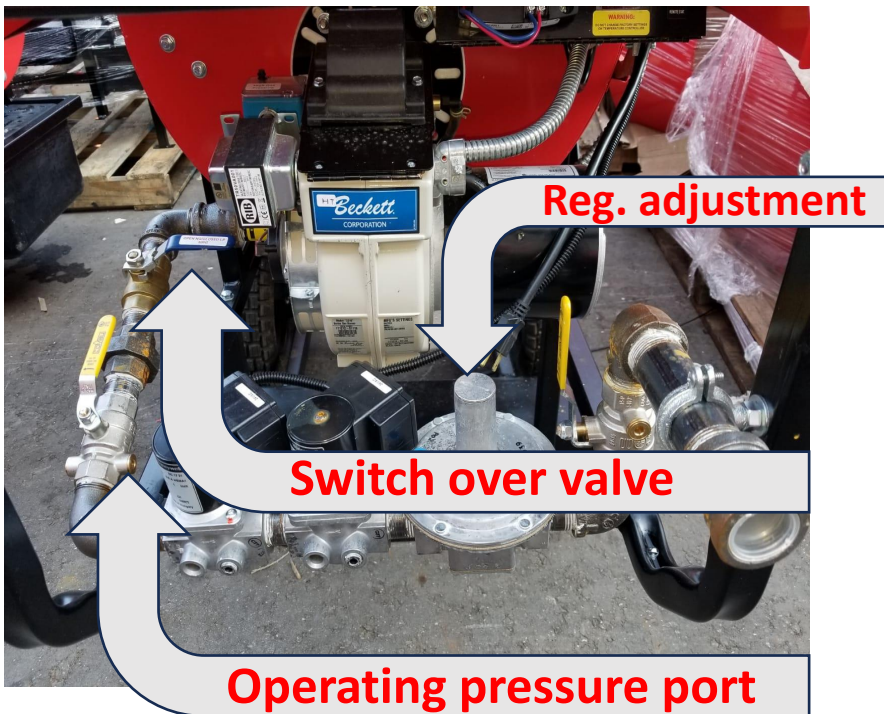

➤ **Note:** operating gas pressures **LP 5" WC** and **NG 3.8" WC** taking at the manual gas valve before the switchover valve.

- 1. Determine if unit will be run on NG or LP. For NG operation make sure that NG/LP blue handle easy switchover valve located on the manifold side of the train is in the open position for NG operation ensure it is in the closed position for LP.

➤ Back to information menu...[Page 33](#)

➤ Start-up continued...[Page 45](#)

[HOME](#)



2. Determine whether the unit will be powered with **3PH 208V** or **1PH 240V** and follow wiring instructions stipulated on the main serial number decal.
3. Tap control transformer located in control panel for **208V or 240V** according to your power supply voltage. Note: Voltage should be between **208 and 240** volts with **220 volts being the target**.
4. Be sure to supply no more than **14" WC** to the heater when the heater is OFF. When the burner is running supply pressure should be between **7" to 14"** of WC.
5. Have a qualified gas fitter determine the correct regulators to use and the correct diameter hose to feed the unit with fuel according to pressure in the supply line and length of hose.
6. Be sure to fit the unit with a **36"** stack on the flue with **rain cap**. Make sure your gas fitter assesses if there will be any negative air pressure and to take the appropriate measures to avoid negative pressures on the flue of the heater. Be sure to always terminate any flue stack set ups in a 3 - foot vertical position and follow the instructions on the decal/diagram located on the heater or manual for longer stack runs. Also, when running the unit for the first time make sure that flue gases are not being sucked in by the cooling fan and pushed into the space you are heating.

Start up procedure...



- 1. Power up heater. Turn main switch “ON” and controls “ON”. If running without a thermostat leave toggle switch in bypass position, if running with a thermostat then place toggle switch in thermostat position.
- 2. It is imperative to check control voltage when the unit’s cooling fan is running in high speed (Fan speed 3). With your voltmeter or using the heaters panel mounted voltmeter in the control voltage position ensure that the control voltage is not less than 108 Volts and not more than 132 Volts when fan is running at full speed.
- 3. Turn the switch to the “Heat” position. Burner will cycle on and purge the heat exchanger before ignition. If the burner fails to light, make sure all ball valves are open and that your manometer on the manifold side of the train is giving you a reading when the burner is attempting to light. If the burner does not light adjust your shutter and air band vents on the burner until it lights. Start by decreasing the air and if it doesn’t ignite then increase the amount of air until the burner ignites.



- **No installation** is complete until the combustion of the heater has been performed.
- 10. Once the burner is running adjust the manifold pressure to the pressure stipulated on the main serial number plate of the unit using the adjusting screw located on the pressure regulator located before the solenoid valves. For the Blaze 1000G for NG the manifold pressure must be **3.8” of WC** and for LP operation it must be **5” of WC**. When you have set the manifold pressure ensure that incoming pressure is between 7” to 13” of WC when the burner is running.
- 11. Once the burner has been running for 5 minutes insert your combustion analyzer probe into the flue stack. Adjust air settings on burner until you have an Oxygen reading of **3 % to 4%** and then ensure that your CO levels are **0-50PPM**.
- Using a Combustion analyzer...[Page 48](#)
- Gas train adjustment ports...[Page 50](#)

Clean & Reliable Combustion Natural Gas, Propane.

➤ **Note:** Be sure to set your analyzer for Gas, or Propane.

Set the air settings to manufacture's recommendations... [Page 49](#) Start the burner and let it operate for 10 minutes. Adjust the air settings to achieve between 3% to 4% oxygen O₂. Check the CO (Carbon Monoxide) level, it should not be higher than 50 PPM.

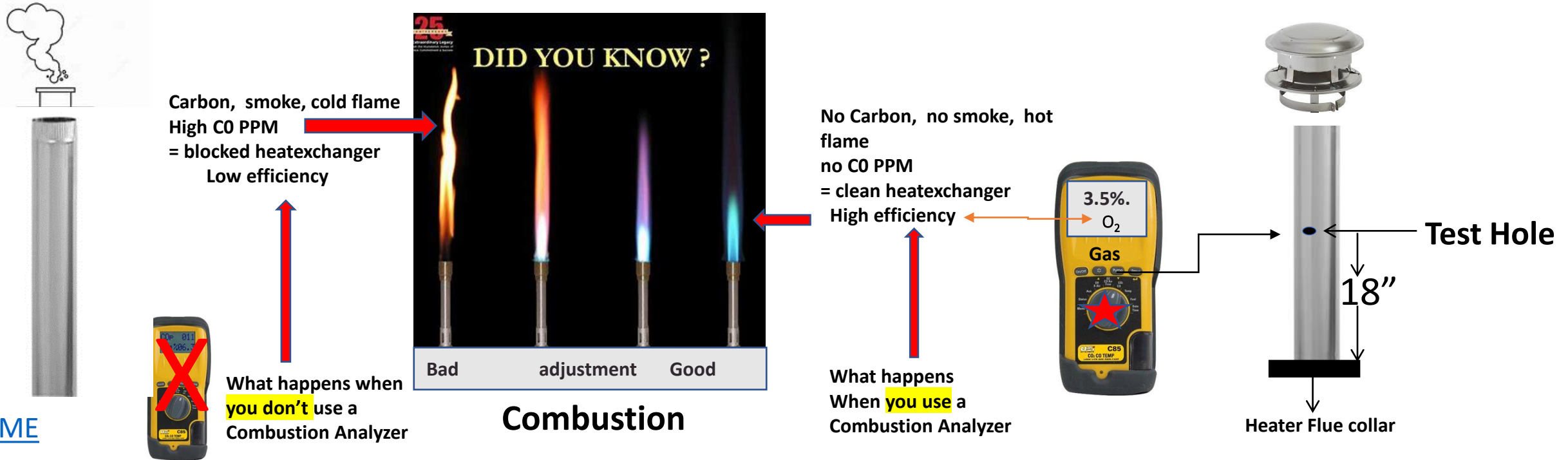

Start up complete

Back to information menu... [Page 33](#)

Combustion and adjusting the air settings.



Proper air adjustments must be preformed for reliable combustion



Band Shutter

- Recommended air settings are indicated in manufactures instructions as **10/5** the first number being the shutter and the **second number being the band**.
- **Note:** recommend air settings are approximate and will change with altitude, and air temperature.
- **The Use of a combustion analyzer** will ensure clean burning and maximum efficiency.

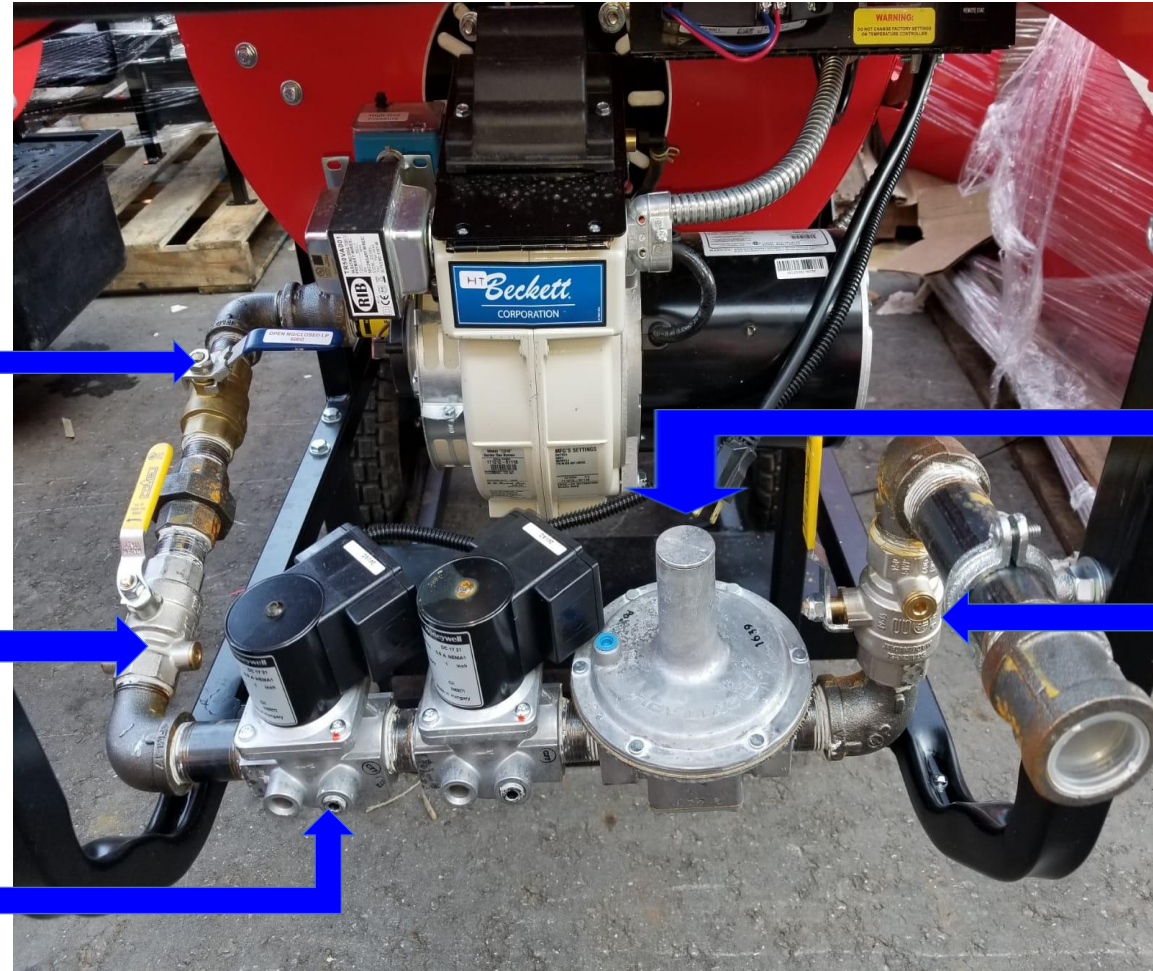

Switchover valve

Pressure regulator adjustment under cap

Outlet pressure port

inlet pressure port

Gas solenoid valve test port

[HOME](#)

Back to startup... [Page 45](#)



The EB1000G can be used in most applications with ductwork.

The maximum outlet (supply air) is 400 feet. The **maximum** inlet (return air) is 50 feet.

Total ducting, Outlet plus Inlet **not to exceed 400** feet.

➤ Best practices...

- ✓ Never exceed the 400 feet of total ducting and 50 feet of air inlet ducting.
 - ✓ If flexible ducting is used, there should be no kinks in ductwork.
 - ✓ Weather flexible or solid ducting is used, try to avoid sharp 90° turns.
 - ✓ If ducting is split into 2 locations, use a TY not a T. and a maximum of 200 feet total ducting.
 - ✓ If ducting is split into 2 locations, ensure the volume of air passing through is equal to or greater than the single outlet of the heater.
 - ✓ Ensure all ducting is properly protected from water, traffic, and other obstructions.
- **Note:** Improper ducting will cause overheating and short cycling which will damage the heater.

Return to installation and start up menu... [Page 33](#)



- **Note:** Usually when the thermocouple is defective, the Temperature Controller will indicate odd readings in the display window.

Example.. 0000 or high numbers, 700 or 800

In this case....



Testing the thermocouple...

Remove the (small) red and white thermocouple wires from the terminal block located in the control panel on **#11** white and **#12** red. Place a jumper wire between the two terminals **#11** And **#12** on the temperature controller

- ✓ if now the display reads the ambient temperature, defective thermocouple
- ✓ If the display continues to read odd numbers, defective temperature controller

Tip on replacing the thermocouple... [Page 53](#)

Return to previous... [Page 29](#)



Tech Tip

With the side panels removed.

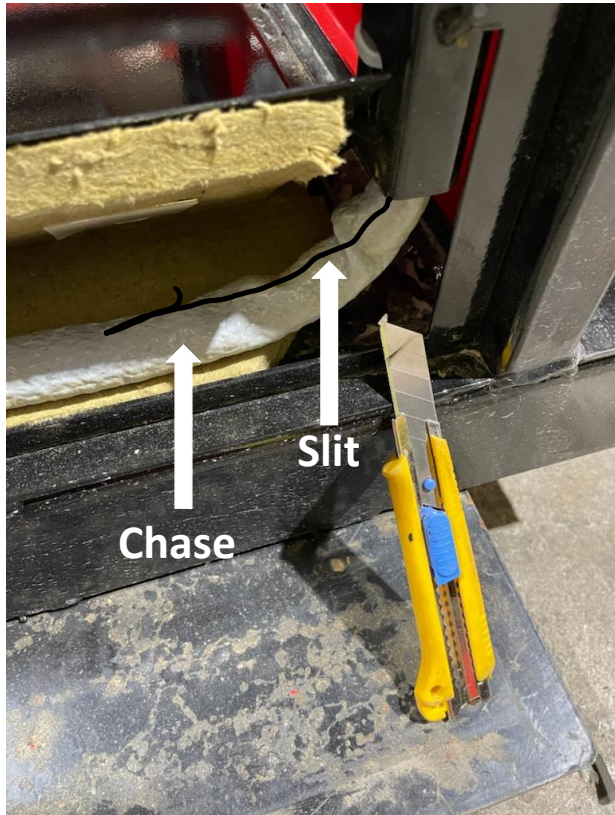

1. Remove thermocouple wire from the bottom of the terminal block in the panel.
2. Attach a string to the end of the wires using electrical tape insuring the knot is not too large.
3. Locate the chase that the thermocouple passes through in the heater casing.
4. Using a box cutter cut a 4 inch slit in the chase casing. (**careful not to cut into wires inside**).
5. Locate the thermocouple wire through the slit.
6. Pull the thermocouple wire through the slit while someone else pushes it from panel.
7. Once the string reaches the slit have someone pull the thermocouple from the burner end of the heater while someone pushes it through the slit.
8. With the old thermocouple removed attach the string onto the new thermocouple wires insuring electrical tape insuring the knot is not too large.
9. Now reverse the procedure and reinstall the wires to the terminal block, white to white, red to red.

[HOME](#)

Return to previous... [Page29](#)

Tech Tips And Bulletins and more for You...



Don't get left behind. Stay on the top of your game and become a...
“ Campo Field Assist Program Member”.

- As a member you will receive updates and notifications of any changes to the Guides.
- As a member you will be notified of upcoming courses.
- As a member you will be first to receive any new “Field Assist Troubleshooting Guides”
- As a member you will receive more “Tips” to make your job easier.

“It’s quick, simple and easy, join us today”



1. Open the QR code by pointing the camera with your cell phone or tablet
2. Fill out the VERY SHORT registration form and hit Submit/Send.

Or www.campoequipment.com/techsupp

We pride ourselves in offering...
The best technical support in the industry

“Field Assist Troubleshooting Guide”



[HOME](#) sales@campoequipment.com



1-866-323-0042



Natural Gas and Propane Burner

Preform and Record combustion results:

Check

O2 PERCENTAGE (oxygen)

✓ done

CO parts per million (ppm carbon monoxide)

✓ done

Remove gas gun assembly adjust electrodes check for cracks and clean

✓ done

Lubricate o ring on gun assembly

✓ done

Clean flame rod

✓ done

Check ignition cable

✓ done

Start burner and check control safety lock-out

✓ done

Check and adjust gas pressure Hi fire and Low fire

✓ done

Clean blower wheel (remove dust)

✓ done

Check air switch hose for cracks

✓ done

Check gas train fittings for leaks

✓ done

Start heater and check operation of thermostat /bypass

✓ done

[HOME](#)

Continue [Page 57](#)



| Heater controls | Check |
|--|--------|
| Test temperature controller. Fan on at 90F / Fan off at 80F Burner off 30 F above set high limit / Burner back on at high set temp | ✓ Done |
| Check circulating fan, (Fan timer, Fan relay, 110F disk) | ✓ Done |
| Check wiring terminals inside control panel, tighten if lose | ✓ Done |
| Clean heater casing and check for dents | ✓ Done |

➤ **Note:** Pre-season annual maintenance will save you time, money and service calls every time you rent the unit.

Back to previous menu... [Page 33](#)

Gas piping, and regulator sizing...



➤ **Note:** All gas piping should be calculated and installed by a qualified Gas fitter. Gas fitters have charts for sizing gas pipes and proper regulators for different pressures and installations.

It is important to use the right sizing piping charts for your area. Code regulations vary from different States and Provinces.



➤ Regulator sizing example...[Page 59](#)



Natural Gas and Propane Regulator Examples...



1. Obtain the specifications included with the operational instructions for gas heaters.
2. Size the gas regulator according to the gas **inlet** pressure available to the heater.
3. Read the **outlet** pressure required for the heater on the heater specification sheet.
4. Size the regulator according to both the **inlet** and **outlet** gas pipe diameter of the gas train.

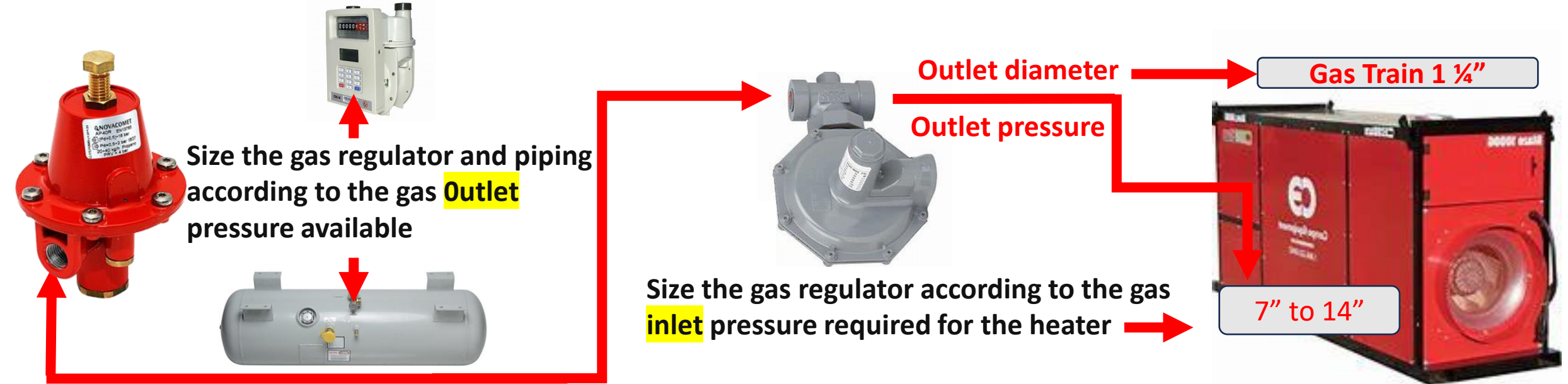

➤ **Note:** The supplied **pressure regulator** with the heater on the gas train is used only to adjust the burner operating pressure. The only time a secondary regulator is not used is when the gas supplied on site from the meter is less than **14"** WC.

Pipe sizing example... [Page 60](#)

Pipe sizing the job site...

"Field Assist Troubleshooting Guide"



➤ WHAT YOU NEED TO KNOW

Where the heater will be placed

What Pressure is available **2 Psig**

Gas type **Natural Gas**

Total BTUs of all units connected to gas piping **3 million**

Length of longest run. **125 feet**

➤ Steve's Job site requiring 1 heater - **1 million BTUs** and 1 - heater **2 million BTUs**.



2 million BTU

?

20 feet



1 million BTU

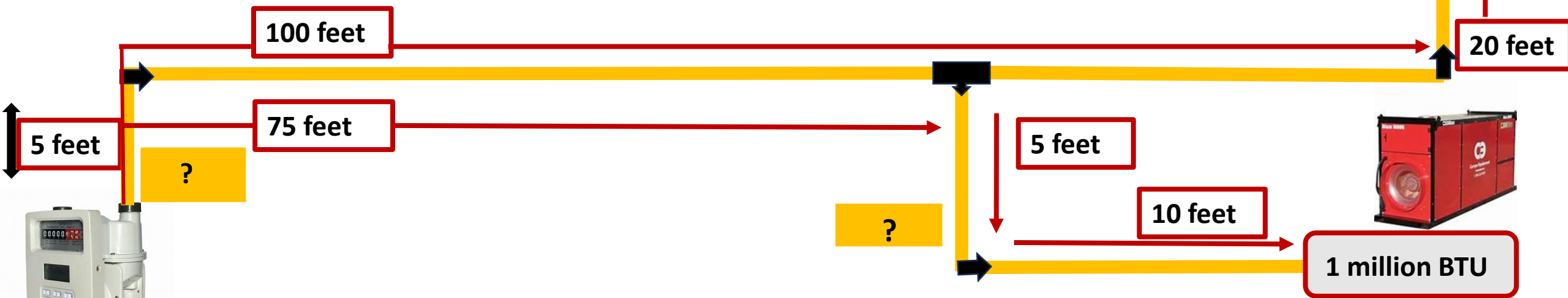

2Psig.

Next... [Page 61](#)

Pipe sizing...

"Field Assist Troubleshooting Guide"



Find size of pipe to the first branch using your 2 Psig chart for NG. and 125-foot run.

Next Consult Chart

| | | Natural Gas | | | | | | | | | | | | | | | | |
|---------------|--|----------------------------------|-------|-------|-------|-------|-------|-------|-------|-------|-------|--------|--------|--------|---|---|----|----|
| | | GAS: NATURAL | | | | | | | | | | | | | | | | |
| | | INLET PRESSURE: LESS THAN 2 psig | | | | | | | | | | | | | | | | |
| | | PRESSURE DROP: 0.5 in. w.c. | | | | | | | | | | | | | | | | |
| | | SPECIFIC GRAVITY: 0.60 | | | | | | | | | | | | | | | | |
| | | PIPE SIZE (inch) | | | | | | | | | | | | | | | | |
| NOMINAL I.D. | 1/8 | 1/4 | 3/8 | 1/2 | 5/8 | 3/4 | 1 | 1 1/4 | 1 1/2 | 2 | 2 1/2 | 3 | 4 | 5 | 6 | 8 | 10 | 12 |
| ACTUAL I.D. | 0.822 | 0.824 | 1.049 | 1.380 | 1.610 | 2.067 | 2.469 | 3.068 | 4.026 | 5.047 | 6.065 | 7.681 | 10.020 | 11.938 | | | | |
| LENGTH (feet) | CAPACITY IN CUBIC FEET OF GAS PER HOUR | | | | | | | | | | | | | | | | | |
| 10 | 172 | 360 | 678 | 1390 | 2090 | 4020 | 6400 | 11300 | 23100 | 41800 | 67600 | 139000 | 252000 | 399000 | | | | |
| 20 | 118 | 247 | 466 | 957 | 1430 | 2760 | 4400 | 7780 | 15900 | 28700 | 46500 | 95500 | 173000 | 275000 | | | | |
| 30 | 95 | 199 | 374 | 768 | 1150 | 2220 | 3530 | 6250 | 12700 | 23000 | 37300 | 76700 | 139000 | 220000 | | | | |
| 40 | 81 | 170 | 320 | 657 | 985 | 1900 | 3020 | 5350 | 10900 | 19700 | 31900 | 65600 | 119000 | 189000 | | | | |
| 50 | 72 | 151 | 284 | 583 | 873 | 1680 | 2680 | 4740 | 9660 | 17500 | 28300 | 58200 | 106000 | 167000 | | | | |
| 60 | 65 | 137 | 257 | 528 | 791 | 1520 | 2430 | 4290 | 8760 | 15800 | 25600 | 52700 | 97700 | 152000 | | | | |
| 70 | 60 | 126 | 237 | 486 | 728 | 1400 | 2230 | 3950 | 8050 | 14600 | 23600 | 48500 | 88100 | 139000 | | | | |
| 80 | 56 | 117 | 220 | 452 | 677 | 1300 | 2080 | 3670 | 7490 | 13600 | 22000 | 45100 | 81900 | 130000 | | | | |
| 90 | 52 | 110 | 207 | 424 | 635 | 1220 | 1950 | 3450 | 7030 | 12700 | 20600 | 42300 | 76900 | 122000 | | | | |
| 100 | 50 | 104 | 195 | 400 | 600 | 1160 | 1840 | 3260 | 6640 | 12000 | 19500 | 40000 | 72600 | 115000 | | | | |
| 125 | 44 | 92 | 173 | 355 | 532 | 1020 | 1630 | 2890 | 5890 | 10600 | 17200 | 35400 | 64300 | 102000 | | | | |
| 150 | 40 | 83 | 157 | 322 | 482 | 928 | 1480 | 2610 | 5330 | 9650 | 15600 | 32100 | 58300 | 92300 | | | | |
| 175 | 37 | 77 | 144 | 296 | 443 | 854 | 1360 | 2410 | 4910 | 8880 | 14400 | 29500 | 53600 | 84900 | | | | |
| 200 | 34 | 71 | 134 | 275 | 412 | 794 | 1270 | 2240 | 4560 | 8260 | 13400 | 27500 | 49900 | 79000 | | | | |
| 250 | 30 | 63 | 119 | 244 | 366 | 704 | 1120 | 1980 | 4050 | 7320 | 11900 | 24300 | 44200 | 70000 | | | | |
| 300 | 27 | 57 | 108 | 221 | 331 | 638 | 1020 | 1800 | 3670 | 6630 | 10700 | 22100 | 40100 | 63400 | | | | |



2 million BTU

?

20 feet



1 million BTU

5 feet

?

10 feet

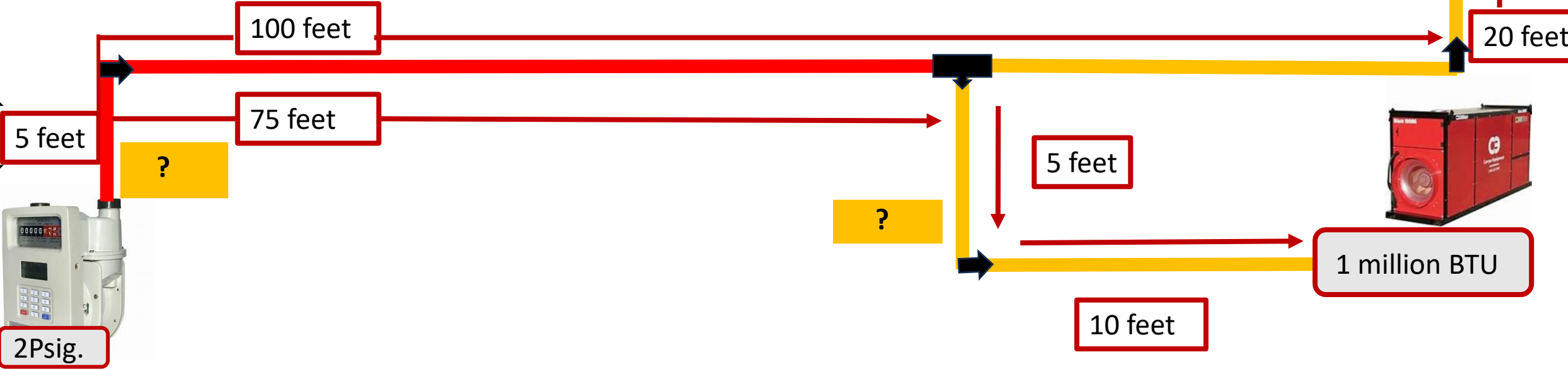

2Psig.

**Pipe sizing Table for 2 pounds Pressure with a 10% Pressure drop and a gas of...
0.6 Specific Gravity**

[Continue...Page 63](#)

| Pipe Size of Schedule 40 Standard Pipe (Inches) | Internal Diameter (Inches) | Total Equivalent Length of Pipe in Feet | | | | | | | | | | |
|--|----------------------------------|---|--------|--------|--------|--------|--------|--------|--------|--------|--------|-------|
| | | 50 | 100 | 150 | 200 | 250 | 300 | 400 | 500 | 1000 | 1500 | 2000 |
| 1.00 | 1.049 | 1112 | 764 | 614 | | | | | | | | |
| 1.25 | 1.380 | 2283 | 1569 | 1260 | | | | | | | | |
| 1.50 | 1.610 | 3421 | 2351 | 1888 | | | | | | | | |
| 2.00 | 2.067 | 6589 | 4528 | 3636 | | | | | | | | |
| 2.50 | 2.469 | 10501 | 7217 | 5796 | | | | | | | | |
| 3.00 | 3.068 | 18564 | 12759 | 10246 | | | | | | | | |
| 3.50 | 3.548 | 27181 | 18681 | 15002 | | | | | | | | |
| 4.00 | 4.026 | 37865 | 26025 | 20899 | | | | | | | | |
| 5.00 | 5.047 | 68504 | 47082 | 37809 | | | | | | | | |
| 6.00 | 6.065 | 110924 | 76237 | 61221 | | | | | | | | |
| 8.00 | 7.981 | 227906 | 156638 | 125786 | | | | | | | | |
| 10.00 | 10.020 | 413937 | 284497 | 228461 | | | | | | | | |
| 12.00 | 11.938 | 655315 | 450394 | 361682 | 309555 | 274351 | 248582 | 212754 | 188560 | 129596 | 104070 | 89071 |

**NO 125-foot then always
use next highest** ↘

➤ WHAT YOU NEED TO KNOW

- What Pressure is available **2 Psig**
- Gas type, **Natural Gas**
- Total BTUs of all units connected to gas piping **3 million**
- Length of longest run. **125 feet**

150 feet-3636 million BTU's = **2"** pipe.

**Pipe sizing Table for 2 pounds Pressure with a 10% Pressure drop and a gas of...
0.6 Specific Gravity**

[Continue...Page 65](#)

| Pipe Size of Schedule 40 Standard Pipe (Inches) | Internal Diameter (Inches) | Total Equivalent Length of Pipe in Feet | | | | | | | | | | |
|--|----------------------------------|---|--------|--------|--------|--------|--------|--------|--------|--------|--------|-------|
| | | 50 | 100 | 150 | 200 | 250 | 300 | 400 | 500 | 1000 | 1500 | 2000 |
| 1.00 | 1.049 | 1112 | 764 | 614 | 525 | 466 | 422 | 361 | 320 | 220 | 177 | 151 |
| 1.25 | 1.380 | 2283 | 1569 | 1260 | 1079 | | | | | | | |
| 1.50 | 1.610 | 3421 | 2351 | 1888 | 1616 | | | | | | | |
| 2.00 | 2.067 | 6589 | 4528 | 3636 | 3112 | | | | | | | |
| 2.50 | 2.469 | 10501 | 7217 | 5796 | 4961 | | | | | | | |
| 3.00 | 3.068 | 18564 | 12759 | 10246 | 8769 | | | | | | | |
| 3.50 | 3.548 | 27181 | 18681 | 15002 | 12840 | | | | | | | |
| 4.00 | 4.026 | 37865 | 26025 | 20899 | 17887 | | | | | | | |
| 5.00 | 5.047 | 68504 | 47082 | 37809 | 32359 | | | | | | | |
| 6.00 | 6.065 | 110924 | 76237 | 61221 | 52397 | | | | | | | |
| 8.00 | 7.981 | 227906 | 156638 | 125786 | 107657 | | | | | | | |
| 10.00 | 10.020 | 413937 | 284497 | 228461 | 195533 | | | | | | | |
| 12.00 | 11.938 | 655315 | 450394 | 361682 | 309553 | 274351 | 248582 | 212754 | 188560 | 129596 | 104070 | 89071 |

Total BTUs on branch = 2000,000
Total length of run = 125 feet

150 feet-3636 million BTU's = 2" pipe.

No 125 foot on chart must use next highest footage.

Pipe sizing...



1. Natural Gas chart 2Psig.
2. Total BTUs of all units connected Branch **1 Million BTUs**
3. Total Length of Branch = **95 feet**

Next find out the size of the pipe on the branch using the total feet from the meter to that unit run (**95 feet**) and the total BTUs on that branch

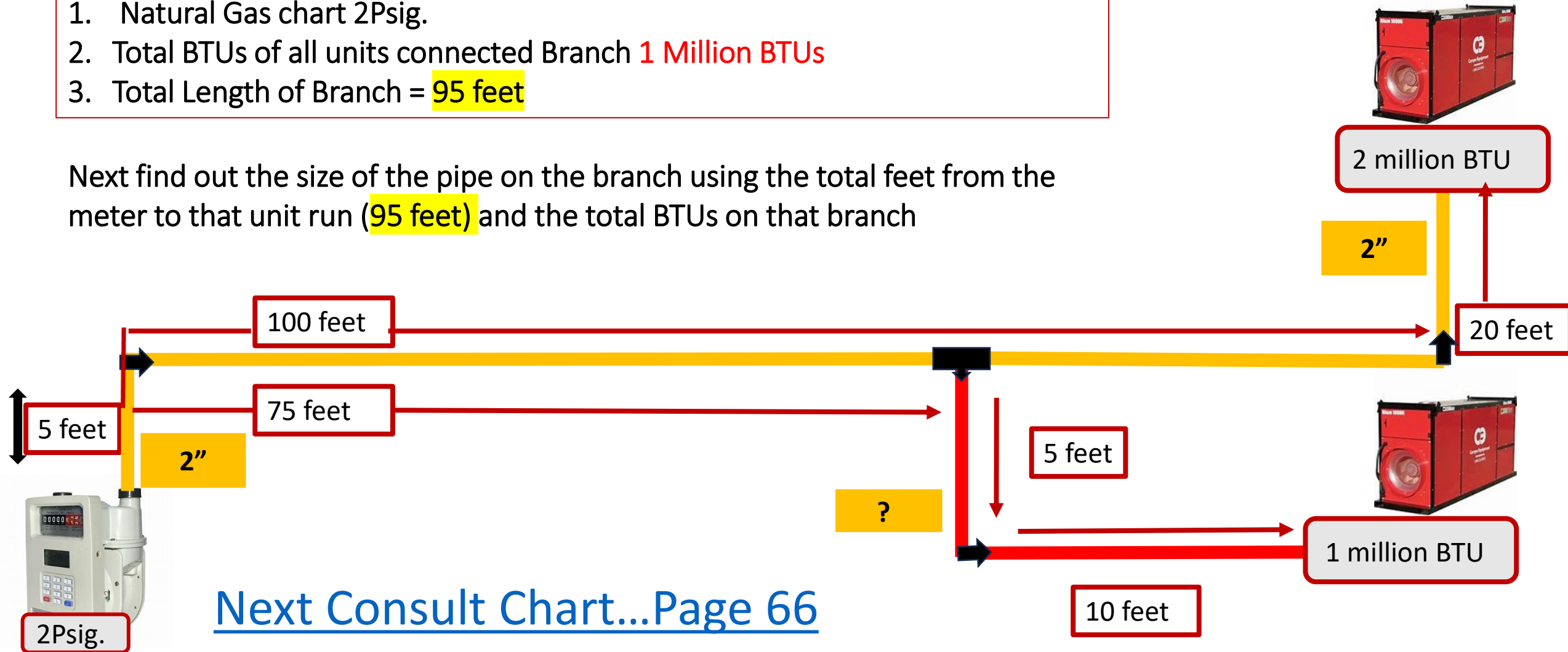

Next Consult Chart...Page 66

**Pipe sizing Table for 2 pounds Pressure with a 10% Pressure drop and a gas of...
0.6 Specific Gravity.**

[Continue... Page 67](#)

| Pipe Size of Schedule 40 Standard Pipe (Inches) | Internal Diameter (Inches) | Total Equivalent Length of Pipe in Feet | | | | | | | | | | |
|--|----------------------------------|---|--------|--------|--------|--------|--------|--------|--------|--------|--------|-------|
| | | 50 | 100 | 150 | 200 | 250 | 300 | 400 | 500 | 1000 | 1500 | 2000 |
| 1.00 | 1.049 | 1112 | 764 | 614 | 525 | 466 | 422 | 361 | 320 | 220 | 177 | 151 |
| 1.25 | 1.380 | 2283 | 1569 | 1260 | | | | | | | | |
| 1.50 | 1.610 | 3421 | 2351 | 1888 | | | | | | | | |
| 2.00 | 2.067 | 6589 | 4528 | 3636 | | | | | | | | |
| 2.50 | 2.469 | 10501 | 7217 | 5796 | | | | | | | | |
| 3.00 | 3.068 | 18564 | 12759 | 10246 | | | | | | | | |
| 3.50 | 3.548 | 27181 | 18681 | 15002 | | | | | | | | |
| 4.00 | 4.026 | 37865 | 26025 | 20899 | | | | | | | | |
| 5.00 | 5.047 | 68504 | 47082 | 37809 | | | | | | | | |
| 6.00 | 6.065 | 110924 | 76237 | 61221 | 52397 | 46439 | 42077 | 36012 | 31917 | 21936 | 17616 | 15077 |
| 8.00 | 7.981 | 227906 | 156638 | 125786 | 107657 | 95414 | 86452 | 73992 | 65578 | 45071 | 36194 | 30977 |
| 10.00 | 10.020 | 413937 | 284497 | 228461 | 195533 | 173297 | 157020 | 134389 | 119106 | 81861 | 65737 | 56263 |
| 12.00 | 11.938 | 655315 | 450394 | 361682 | 309553 | 274351 | 248582 | 212754 | 188560 | 129596 | 104070 | 89071 |

**NO 95-foot then always
use next highest**

1. Natural Gas chart 2Psig.
 2. Total BTUs of all units connected Branch **1 Million BTUs**
 3. Total Length of Branch from meter = **95 feet**

 100 feet-1569 BTU's = **1 ¼"**

Pipe sizing...



Piping for job complete

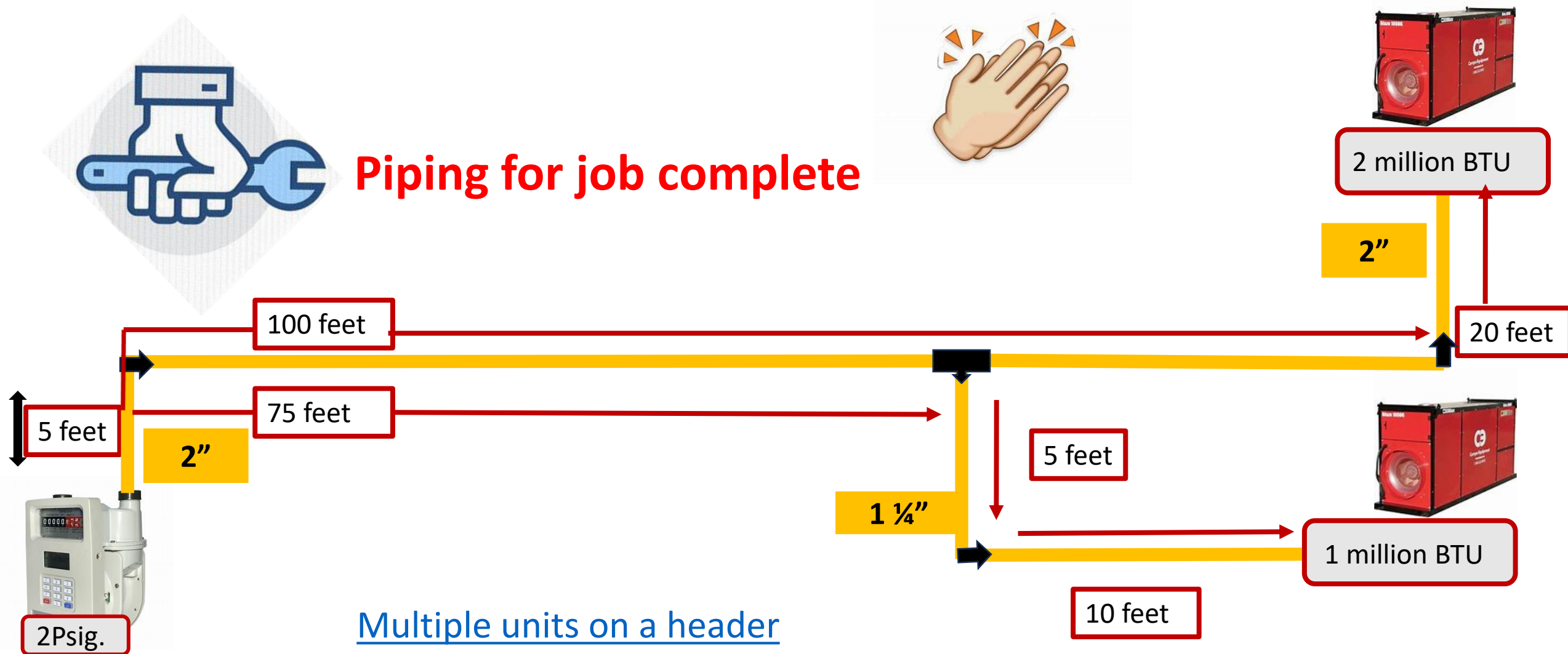

Pipe sizing multiple heaters one header...



Note: any other appliances operating off the same meter would have to be calculated in to piping.

