



Welcome to the Campo “Field Assist Troubleshooting Guides”.

These guides were developed to assist the working technicians in the field. We’ve supplied issues and solutions to the most common problems encountered in the field. If you need assistance while troubleshooting on the job, they are easy to store in your smart phone, tablet or computer.

Getting Started is easy! Just click on [Page #](#) for the problem you are encountering

- If your voltage is **240 volts** continue here...
- **The** blower fan starts, but the control is **locked-out alarm**... [Page 2](#)
- **The** blower fan starts, and the burner control is **NOT locked-out**...[Page 7](#)
- **No heat** and the blower fan won't start...[Page 10](#)
- If your voltage is **480 volts**... [Page 57](#)
- **The** blower fan won't stop automatically after call for heat is satisfied...[Page 17](#)
- **The 'overheat reset'** light is illuminated and will not reset...[Page 18](#)
- **The** burner doesn't modulate...[Page 19](#)
- **Technical** information and more... [Page 23](#)

Burner control is locked-out on reset (Alarm)...

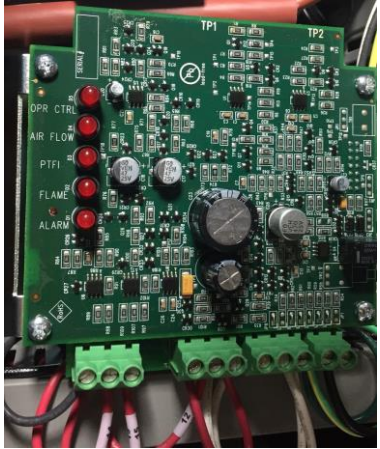

The **Fireeye** controller:





Resetting the control from lockout **Alarm**...In the event of a **lockout** condition, the M4RT1 **can be reset** via a minimum one second power interruption to terminal 7. (**Shutting off main switch and turning it back on**)

The M4RT1 has LED lights to indicate the operating status of the control. The function of these lights are: OPR Ctrl (Operating Control): This LED is lighted whenever input terminal 7 is energized. PTFI: This LED is energized only during the Pilot Trial For Ignition Period. Flame: This LED is lighted whenever an adequate flame signal is detected between the M4RT1 terminals S1 & S2. **Alarm: This LED is energized whenever a safety lockout occurs.**

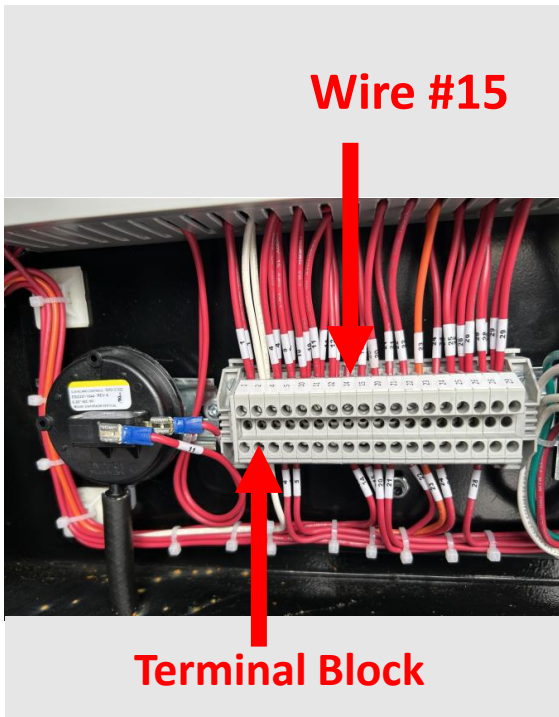
- After resetting the control, the pilot burner doesn't fire up...[Page 3](#)
- The pilot burner fires up but the main burner doesn't fire up...[Page 5](#)

Burner control is locked-out on reset...



- Reset the control and check for **120 volts** on wire **#15** and **#2** on the terminal block.
- ✓ If **120 volts** is **not** present, the Fireeye control is defective. 
- If **120 volts** is present...
 - ✓ The valve is defective. 
 - ✓ The pilot assembly is out of alignment. 
 - ✓ The igniter is defective. 

➤ Testing the components... [Page 4](#)

Testing the components...

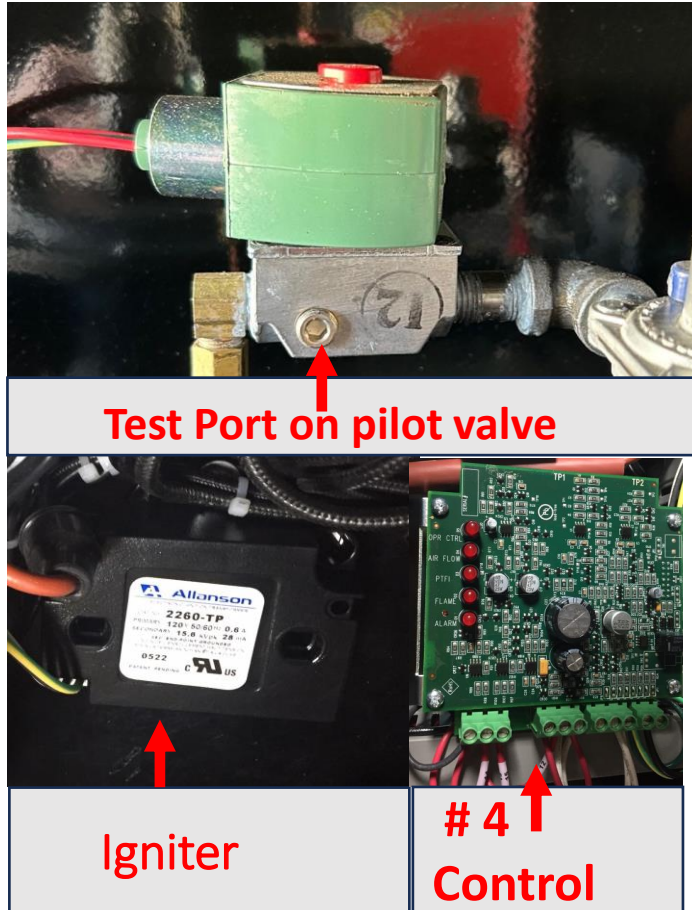

- Install your manometer on the test port of the pilot valve, Reset the control and check to see if gas **is** present to the pilot burner.
- ✓ If gas is **Not** present, defective gas valve.
- If gas **is** present, check for **120 volts** on terminal **#4** on M4RT control.
- ✓ If **120 volts** is not present, defective control.
- ✓ If **120 volts is** present, **With the gas shut off**, check for spark at the pilot burner.
- ✓ If **no** spark defective igniter.
- If spark **is** present, check alignment of electrode to pilot burner.



➤ **Problem solved**

➤ **Note:** the spark can be checked by removing the side panel and accessing the pilot burner and resetting the control

The main burner doesn't fire up...

"Field Assist Troubleshooting Guide"



Terminal Block #14

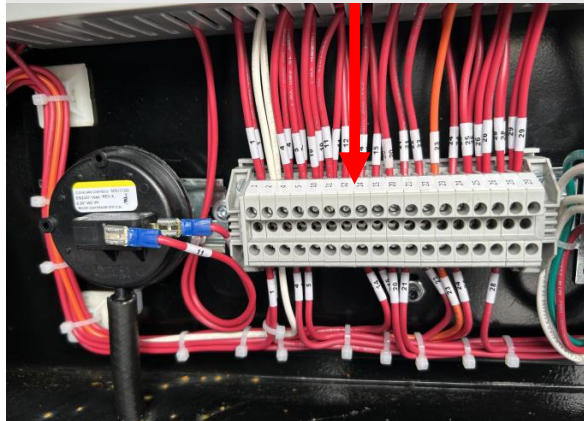

- Reset the control, check for **120 volts** to main burner gas valves on terminal block wire **#14**
- Keep a close eye on the volt- meter, as the voltage will only register for a second.
- If **120 volts** is **not** present, defective control. →

- If **120 volts** is present...
✓ **One** of the 2 gas valves is defective. →

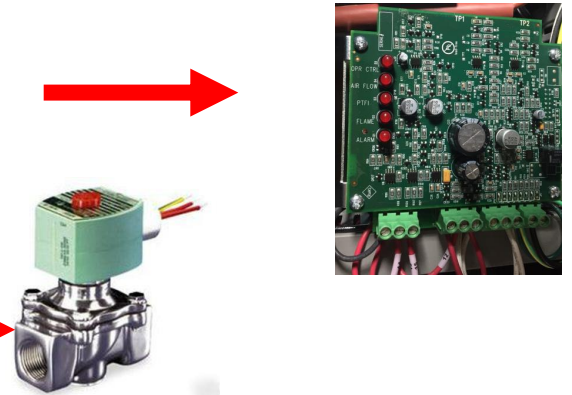

- Testing the main flame gas valves...[Page 6](#)

Main burner Gas Valves

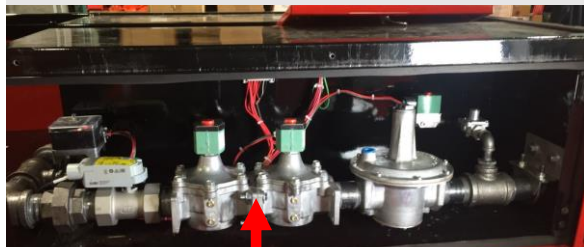

Checking the 2 main burner gas valves...



Note: Bottom fitting is outlet pressure. Top fitting is inlet pressure.

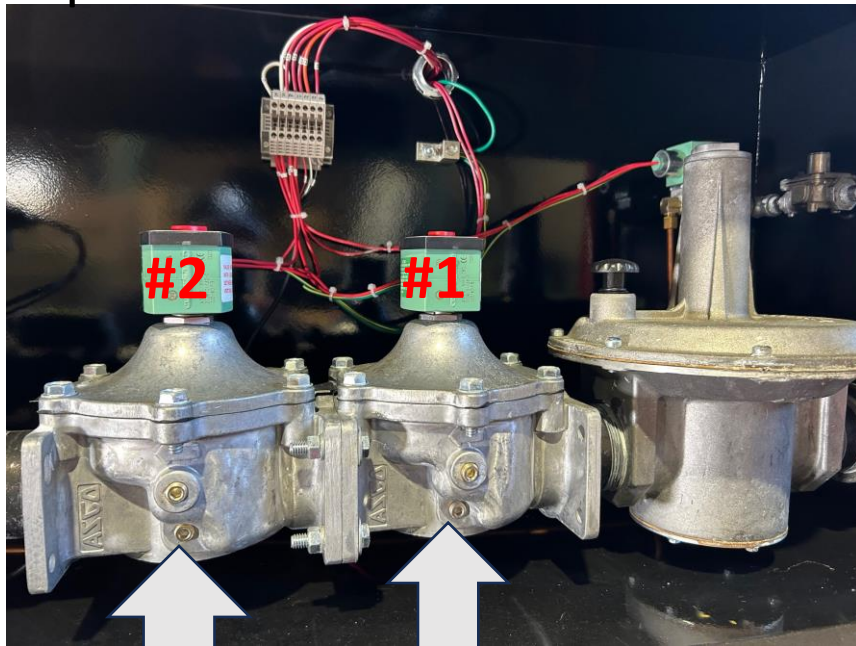

main gas valve # 2

main gas valve # 1

- Install your manometer fitting into the bottom test port of the main gas valve # 1, Reset the control and check to see if gas is present. Keep a close eye on the manometer, as the pressure will only register for a couple of seconds.
- ✓ If gas is not present #1 gas valve is defective.
- ✓ If gas is present, #2 gas valve is defective

➤ Problem solved

Burner control is NOT locked-out on reset the blower fan starts...



#1-#2-#25-@27

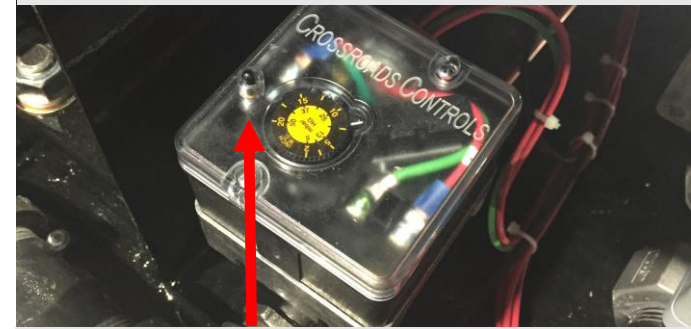

Reset button

high-pressure switch

Thermostat is located inside the blower motor.

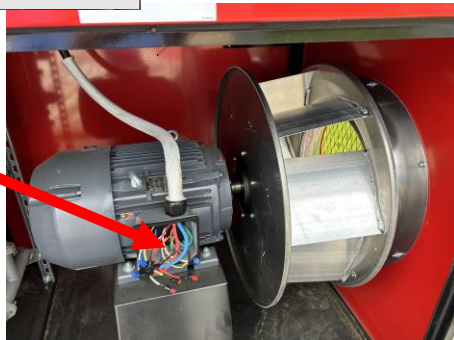

- Check for 120 volts on terminal block between wire #1 and #2
- If 120 volts is not present, [Page # 9](#)
- If 120 volts is present, check for 120 volts on terminal block wire #27
- ✓ If 120 volts is not present, defective high-pressure switch or tripped off on reset.
- If 120 volts is present, check for 120 volts on terminal block wire #25
- ✓ If 120 volts is not present, defective motor thermostat. **Note:** the motor thermostat is located inside the blower motor and is not field serviceable. (Can be taken to motor repair shop or replaced).

➤ If 120 volts is present continue... [Page 8](#)

Burner control is NOT locked-out on reset the blower fan starts...

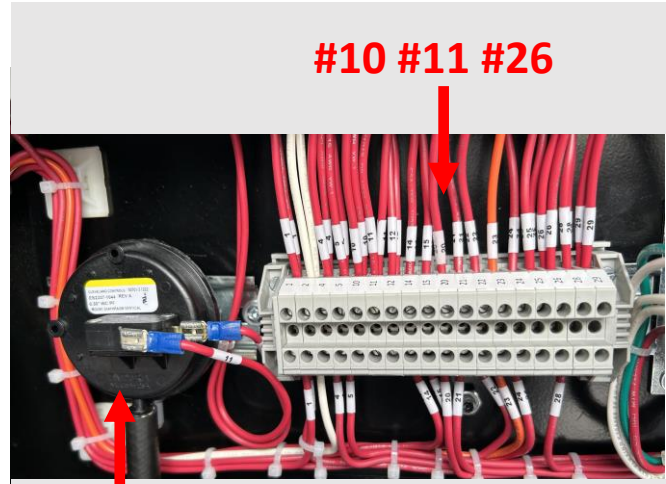

#10 #11 #26



Air proving switch

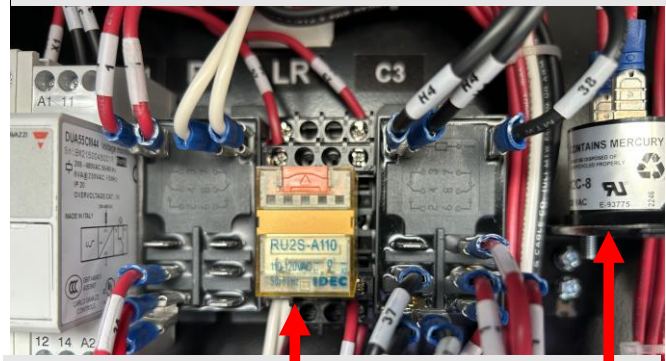

LR relay

Tilt switch

- If 120 volts is present, check for 120 volts on terminal block wire #26
- ✓ If 120 volts is not present, defective tilt switch.
- If 120 volts is present, check for 120 volts on terminal block wire #10
- ✓ If 120 volts is not present, defective LR relay.
- If 120 volts is present, check for 120 volts on terminal block wire #11
- ✓ If 120 volts is not present, defective air switch.
- If 120 volts is present, check for 120 volts on #8 of the DFC+ control.
- ✓ If 120 volts is not present, defective DFC+ control.
- ✓ If 120 volts is present, defective Heat off Fan switch.

Wire #8



DFC+ control

➤ Problem solved

Burner control is NOT locked-out on reset and the fan starts...

“Field Assist Troubleshooting Guide”

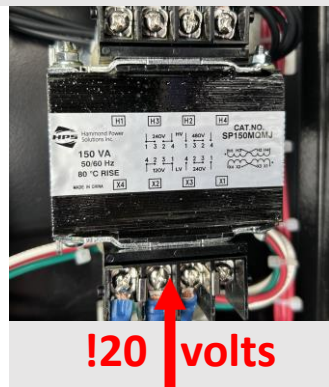
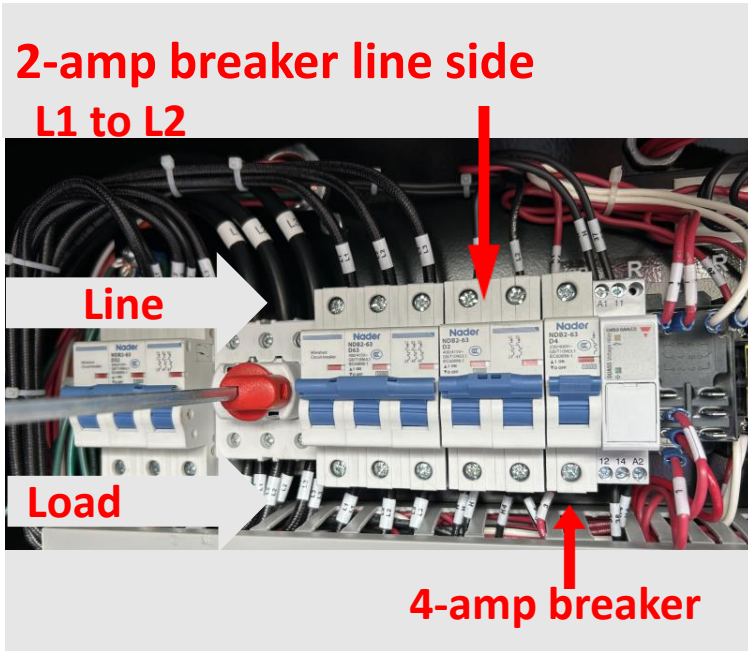

- **Note:** when checking for **120-volts**, always check using the neutral of transformer and not to ground.
- When checking for **208/240 volts** check line to line and not to ground. (L1 to L2)
 - Check for **208/240 volts** on load side of **2-amp** breaker L1 to L2.
 - If **208/240 volts** is **not** present, defective breaker or tripped off.
 - If **208/240 volts** is present, Check for **120 volts** on transformer.
 - If **120 volts** is **not** present, defective transformer.
 - If **120 volts** **is** present, check for **120 volts** on **4-amp** breaker load side.
 - If **120 volts** is not present, defective breaker or tripped off.

➤ **Problem solved**

No heat and the blower fan doesn't start...



➤ **Special Note:** The unit is shipped new with the supply voltage set to **480/240 volts**. If the supply voltage is to be **208 volts**, the taps on the 38KVA transformer must be switched from **240 volts** to **208 volts**. See instructions... [Page 56](#)

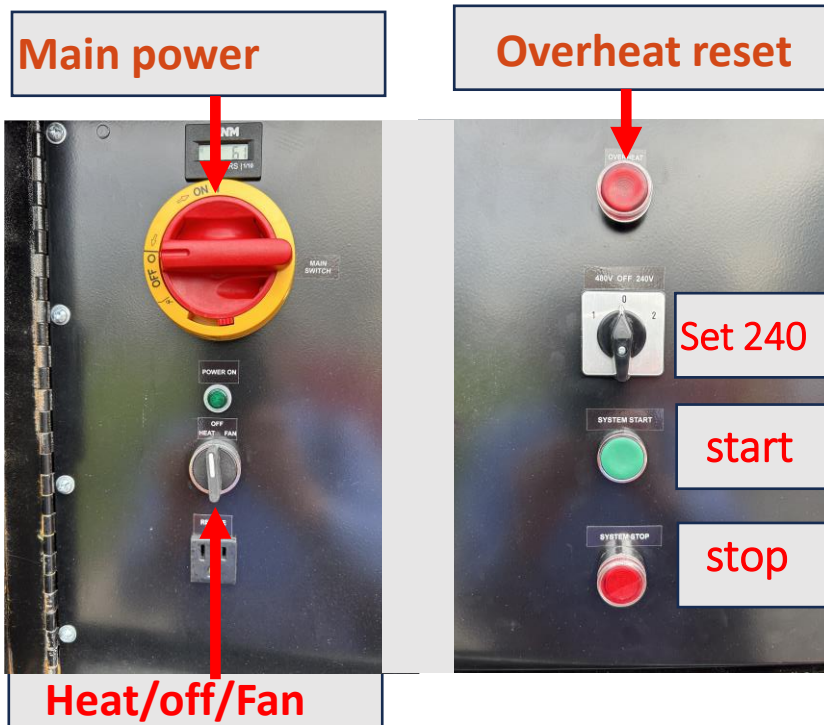

- If the supply voltage is between **240/208 volts**
- Ensure the **240/480 selector switch** is set to **240 volts**.
 - Tie wrap the transfer switch to selected voltage to ensure no error in made during heater operation.
 - Ensure the main power switch is **on**.
 - Ensure the Heat/off/Fan switch is **turned to Heat**.
 - Ensure the overheat switch is **not** off on reset.
 - Ensure the start button is pushed in.

➤ Continue... [Page 11](#)

No heat and the blower fan doesn't start...

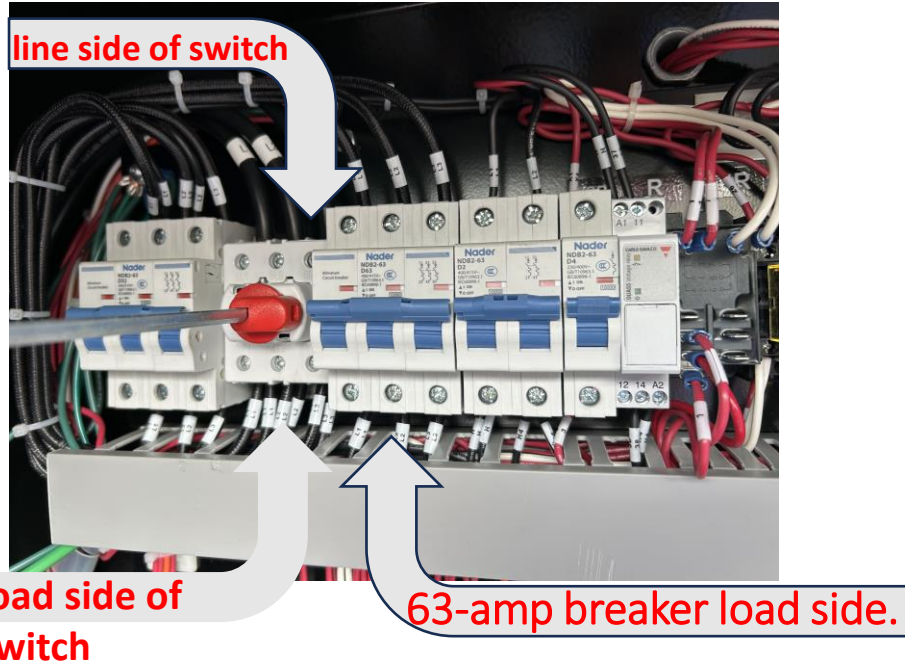

- Before Proceeding, It is **important** to check voltage from phase to phase "**Not**" to ground. **Note**: the DF4500 is **3 phase** only.
- Check for **240/208 volts** on main switch, line side.
- ✓ If **240/208 volts** is **not** present, issue with power supply.
- If **240/208 volts** is present, check for **240/208 volts** on load side of switch.
- ✓ If **240/208 volts** is **not** present, defective switch.
- If **240/208 volts** is present, check for **240/208 volts** on **63-amp breaker** load side.
- ✓ If **240/208 volts** is **not** present, defective breaker or tripped off.
- If **240/208 volts** is present continue...[Page 12](#)

No heat and the blower fan doesn't start...



#1 and #2 on terminal

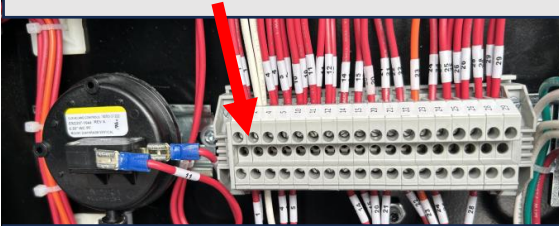

240/208 volts primary
H3-H4

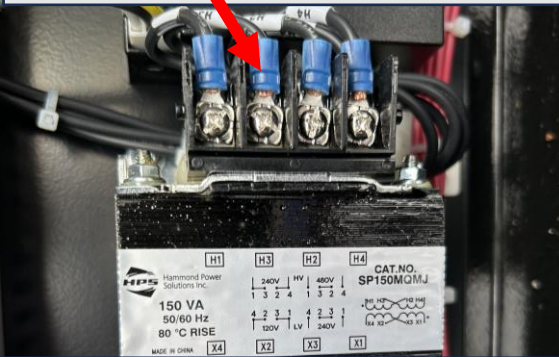

120 volts on secondary



- Check for **120 volts** between #1 and #2 on terminal block.
- If **120 volts** is **not** present, check for **120 volts** on the Red and white wire of the secondary of **150 VA** transformer.
- If **120 volts** **is** present...[Page 14](#)
- If **120 volts** is **not** present, check for **240/208 volts** on primary of transformer **H3** and **H4**.
- ✓ If **240/208 volts** **is** present, defective transformer.
- If **240/208 volts** is **not** present...[Page 13](#)

No heat and the blower fan doesn't start...

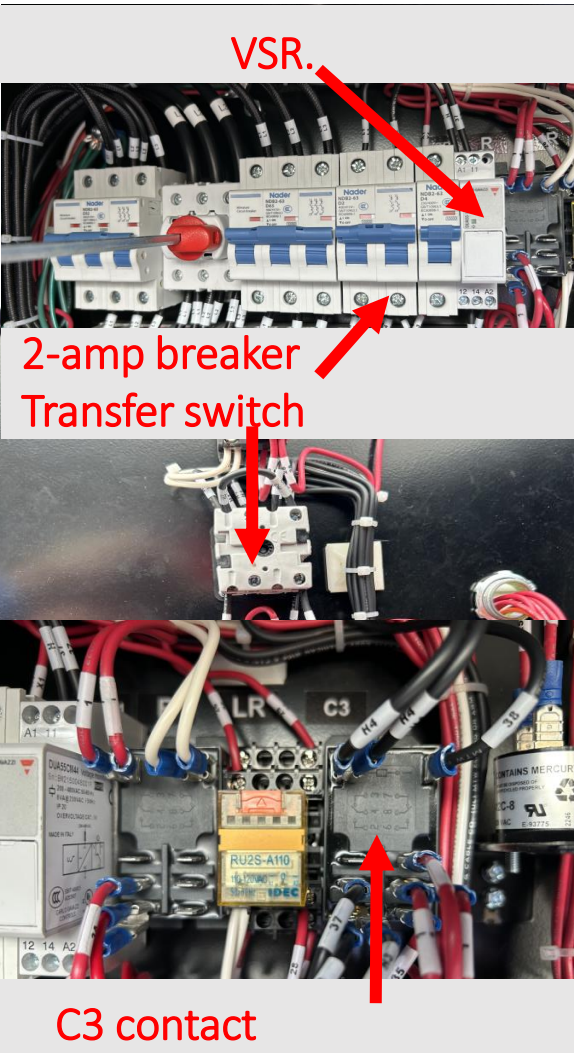

- If 240/208 volts is not present, Check 2-amp breaker. If the breaker is not tripped, check for 240/208 volts on the load side of the breaker H4 and H3.
- ✓ If 240/208 volts is not present, defective breaker.
- If 240/208 volts is present, Check for 240/208 volts on wire #37 and H4 of voltage selector switch.
- ✓ If 240/240 volts is not present, defective voltage selector switch.
- If 240/208 volts is present, check for 240/208 volts on wire #38 and H4 on VSR.
- ✓ If 240/208 volts is not present, defective VSR relay.
- ✓ If 240/208 volts is present, C3 contact is defective.

➤ Problem solved

No heat and the blower fan doesn't start...



4-amp breaker



Start switch

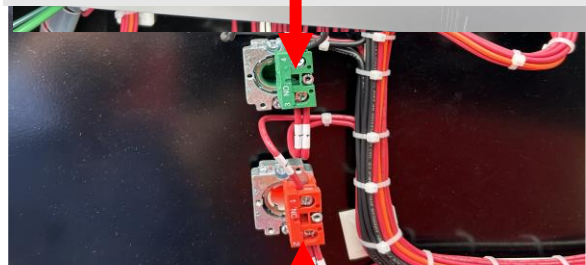

Stop switch

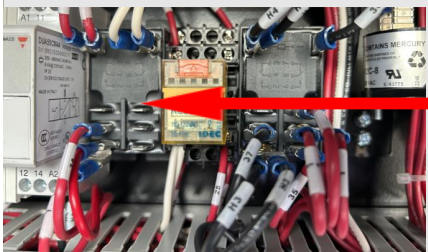

R-Relay

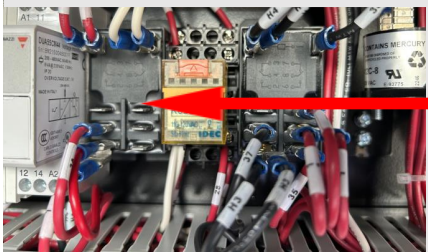

- Check for **120 volts** on wire **#3** on 4-amp breaker.
- ✓ If **120 volts** is **not** present, tripped breaker or defective.
- If **120 volts** is present, check for **120 volts** on wire **#3A** on stop switch.
- ✓ If **120 volts** is **not** present, defective stop switch.
- If **120 volts** is present, press and **hold the start switch in** and check for **120 volts** on wire **#1** on start switch.
- ✓ If **120 volts** is **not** present, defective start switch.
- ✓ If **120 volts** is present, and the unit starts and shuts down when you release the start button, defective R relay.
- If **120 volts** is present, and the unit doesn't start, check for **120 volts** on wire **#35** on **C3** contact.
- ✓ If **120 volts** is **not** present, defective **C3** contact.
- If **120 volts** is present, check for **120 volts** on wire **#36** on **C2** coil.
- ✓ If **120 volts** is **not** present, defective **C1** contact is defective.
- If **120 volts** is present, [Page 15](#)

No heat and the blower fan doesn't start...



- **Note:** The circulating Fan **must start** first before the burner is energized. The VFD controls the blower fan. The VFD is controlled by very **low voltage** to test we use a jumper wire between contacts.
- If **120 volts** is present between **#1** and **#2** on terminal block,
- Place a jumper between **#4** wire and **#5** wire on terminal block. If the fan **doesn't Start** the VFD is defective. **Before replacing the VFD...**
- Turn off power to the heater.
- Remove the cover of the VFD.
- Ensure the terminal blocks are secured properly into place.
- Ensure that all wires are secured into the terminals.
- ✓ Restore power to the heater. If the fan still doesn't start the VFD is defective.

➤ If the fan **Starts...** [Page 16](#)

No heat and the blower fan doesn't start...

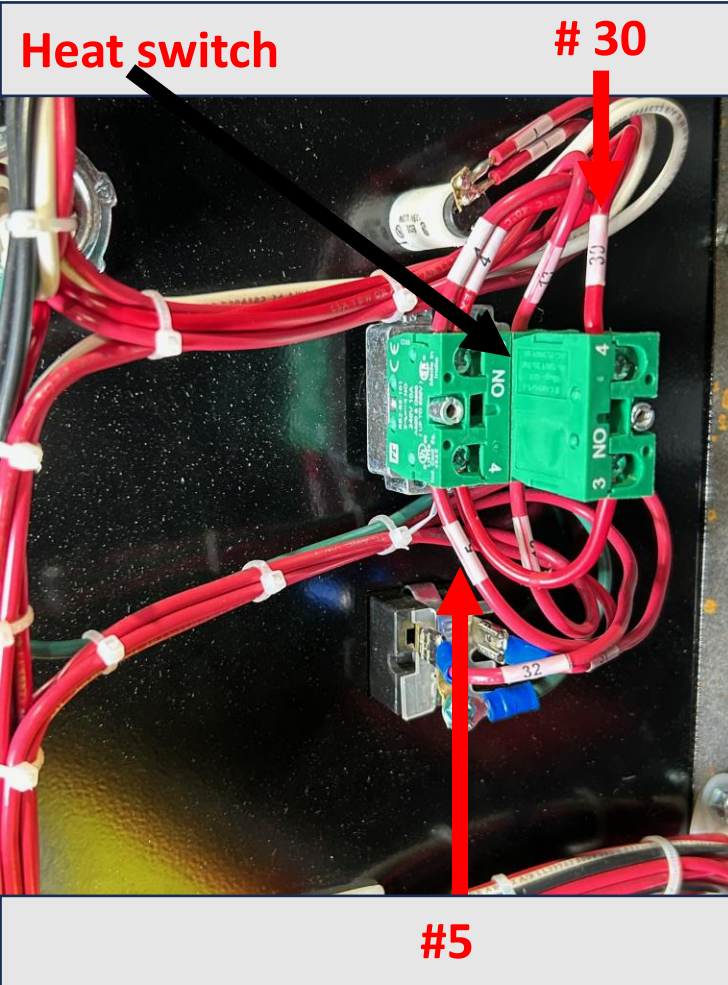

- Place a jumper between #30 wire and #5 wire on heat switch.
- ✓ If the fan Starts the heat switch is defective.
- ✓ If the fan doesn't start the DFC+ is defective.



DFC+ control ↑

➤ Problem solved

Fan doesn't stop automatically...

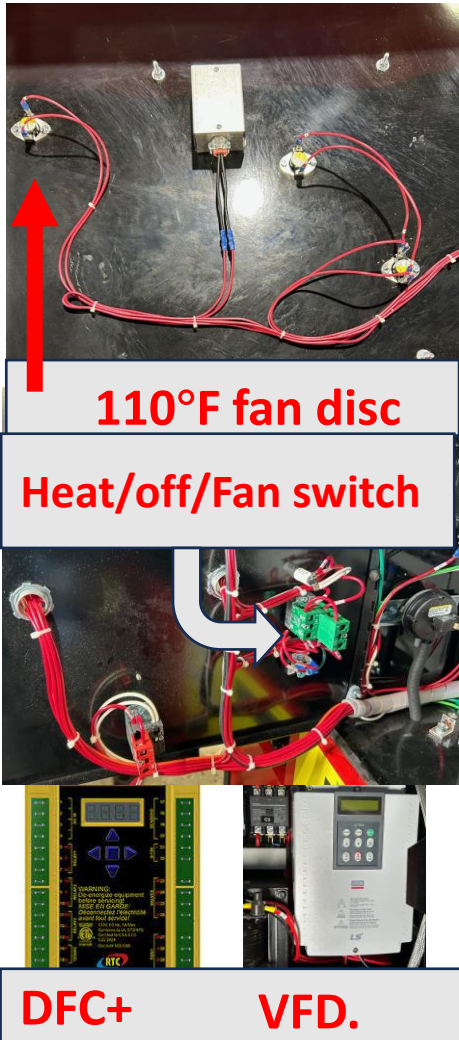

- If the blower fan won't **stop** automatically after a call for heat is satisfied. Check to ensure the Heat/Off/Fan switch is **not on Fan**. Ensure the air temperature is below 80°F.
- With the Heat/Off/Fan switch in the **off-position**, remove both wires from the **110°F fan disc**.
 - ✓ If the fan continues to run, defective VFD.
 - ✓ If the fan stops, check for continuity between both terminals of the 110°F fan disc. If there is continuity, defective disc.
- If there is **no** continuity, and the fan continues to run, remove **#4 wire** on the Heat/off/Fan switch.
 - ✓ If the Fan stops running, defective switch.
- If the Fan continues to run, remove **#5** wire on the Heat/off/Fan switch. If the Fan stops running, defective Heat/off/Fan switch.
 - ✓ If the Fan continues running, defective DFC+ control.

➤ **Problem solved**

The 'overheat reset' light is illuminated and will not reset...

"Field Assist Troubleshooting Guide"

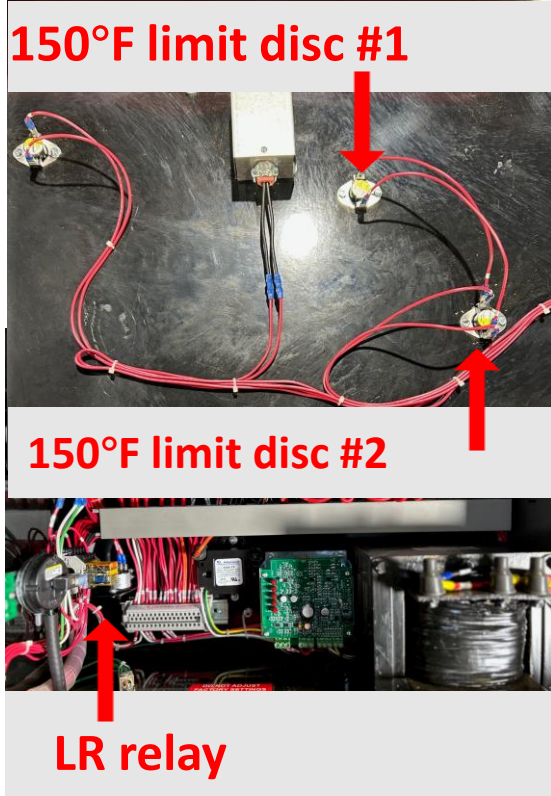

- The EB4500DF is equipped with a manual "overheat switch". If the switch trips off and the light is illuminated, it indicates an air flow issue.
 - If the overheat switch won't reset...
 - Shut off the main switch and remove wire # 28 from the 150°F limit disc #1 as indicated in picture.
 - Restore the power and reset the overheat switch.
 - ✓ if it now resets, disc #1 is defective.
 - If it does not reset, repeat process with disc #2
 - ✓ if it resets, disc #2 is defective.
 - ✓ If it does not reset, remove the LR relay from the relay base. If the overheat switch resets, defective LR relay.
 - ✓ If it does not reset, defective overheat switch'

➤ Problem solved

Orange tab to disconnect
From circuit

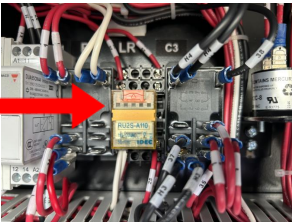

The burner doesn't modulate...

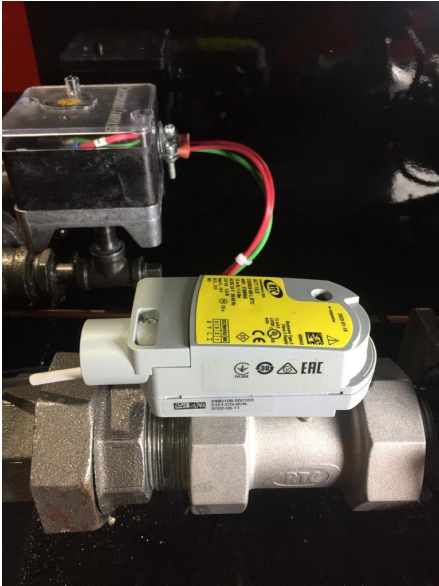

24	24VDC Valve Output
25	0-10VDC Valve Output
26	Valve Ground

- **Note:** The burner only modulates to the low set point when using the remote thermostat. When **no thermostat** is used it modulates to 250°F
- **Note:** Voltage on these terminals are **DC**
 - Check for **24 volts DC** on terminal **#24** of DFC+ and **0-10 volts DC** on terminal **#25** of DFC+ to Valve Ground.
- ✓ If these Voltages are Not present, defective DFC+
- If voltages are present, defective valve or valve damper is stuck.
- Remove the motor and operate the valve damper manually.
- ✓ If the damper moves freely, the motor is defective

➤ Check the discharge temperature sensor... [Page 17](#)

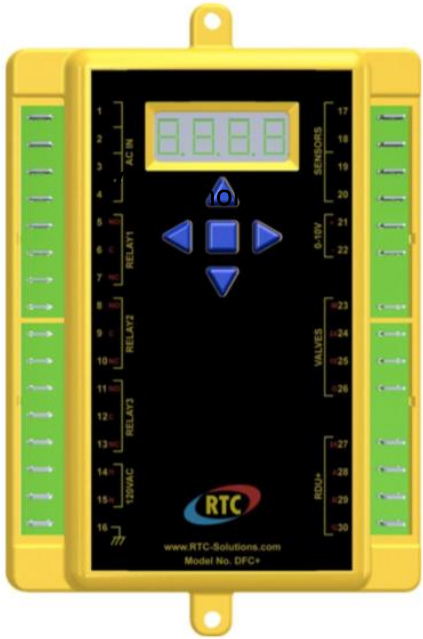

Error messages on the DFC+ will be scrolled across the display with a detailed message. “dFtS oPEn” – There is no Discharge Temperature Sensor connected to the DFC+. “dFtd oPEn” – The user has the Remote (“rE”) parameter on the RDU+ enabled, but no external control is found to take a reading. “dFts ShortEd” – There is a short in the connection of the Discharge Temperature Sensor. “dFtd ShortEd” – The user has the Remote (“rE”) parameter on the RDU+ enabled and there is a short in the connection.

- If there is a message displayed on the DFC+ screen, unplug the Heater and plug it back in.
- If the message goes away the heater should operate properly.
- If the message stays on the display, defective discharge sensor or loose wire.



Don't get left behind. Stay on the top of your game and become a...
“ Campo Field Assist Program Member”.

- As a member you will receive updates and notifications of any changes to the Guides.
- As a member you will be notified of upcoming courses.
- As a member you will be first to receive any new “Field Assist Troubleshooting Guides”
- As a member you will receive more “Tips” to make your job easier.

“It’s quick, simple and easy, join us today”



1. Open the QR code by pointing the camera with your cell phone or tablet
2. Fill out the VERY SHORT registration form and hit Submit/Send. Or www.campequipment.com/techsupp

➤ Back technical information... [Page 20](#)



We pride ourselves in offering...
The best technical support in the industry



training@campoequipment.com



1-866-323-0042

➤ Back technical information...[Page 20](#)



Choose the information you are looking for and click on Page #

- **Set-up** procedure...[Page 24](#)
- **Startup** procedure...[Page 25](#)
- **Electrical** hook up...[Page 31](#)
- **Gas Piping** and regulators...[Page 32](#)
- **Annual** maintenance...[Page 36](#)
- **Gas train** and test ports...[Page 35](#)
- **Gas burner** pressures...[Page 38](#)
- **Operation** of DF2500...[Page 26](#)
- **Operation** of DFC+...[Page 29](#)
- **Operation** of discharge sensor...[Page 28](#)
- **Operation** of modulating gas...[Page 27](#)
- **Main** burner and Pilot burner...[Page 30](#)
- **Contact** us...[Page 22](#)
- **Gas** chart examples...[Page 39](#)
- **To receive** Field Assist Troubleshooting Guides, ...[Page 21](#)



Special Note: It is important to secure the gas train with a pipe wrench while fastening the pipe connections to the heater. **Failure to do so will cause damage** to the gas train components.

1

The heater should be installed level and on solid ground or base. noncombustible (material).

2

The heater must be placed at least 10 feet from any LP or Gas container.

3

The heater should not be installed in an area where combustible gases are circulating.

4

The discharge air stream of this heater must not be directed toward any LP-Gas container within 20 Ft (6.1M).

5

The heater should have the proper size wiring for voltage and amperage demand...[Page 31](#)

6

All gas piping and wiring cables should be routed so they are protected from water or traffic.

7

Ensure all piping and fittings are free from gas leaks.

8

Ensure proper ducting of heater respecting limitations...[Page 34](#)



- **Note:** When connecting the power to the heater you must start the burner within 5 minutes or the DFC+ will display an error message. Shutting off the power and restoring it will clear the error message.
 - Determine if unit will run on Natural gas or Propane.
 - Make sure that the proper gas pressure is set for Natural gas or Propane. Pressure settings [Page 35](#)
 - Make sure the incoming gas pressure is between 7" and 14" WC.
 - Make sure the proper voltage is supplied to the heater.
 - Make sure the proper size wiring is connected to the heater.
 - With the switch for the burner in the off position, plug in the heater, turn the fan manual override switch to ON position and ensure voltage remains steady. Return fan manual override switch to OFF position.
 - Place the Heat/Off/Fan switch in Heat position to start the burner.
 - Once the main burner is running make sure that incoming pressure is between 7" and 14" of WC .
 - If the pressure drops out when running, it means that there is not enough volume of gas or not enough pressure.
 - If the **gas pressure drops**, make sure the gas regulators and piping are correct and gas supply is adequate.
 - If there is more than 1 heater or appliance on the same piping all units should be running during testing for pressure drop.
- Back to information menu... [Page 23](#)



On a call for heat (the heat switch is turned on) The circulating fan starts up and the air proving switch contacts close. The burner control energizes the pilot gas valve, and the spark igniter lights the pilot burner. Once flame has been proven the main flame gas valves open and the main burner flame comes on.

Note: The blower will start and purge the unit for a pre-set time (2-5 sec.) before the ignition sequence will begin.

Once the pilot flame has been established, the main flame will come on and will begin to adjust as needed to maintain the discharge air temperature at the pre-set temperature. The burner only modulates to low set temperature while using the remote thermostat,

➤ Back to technical information menu...[Page 23](#)

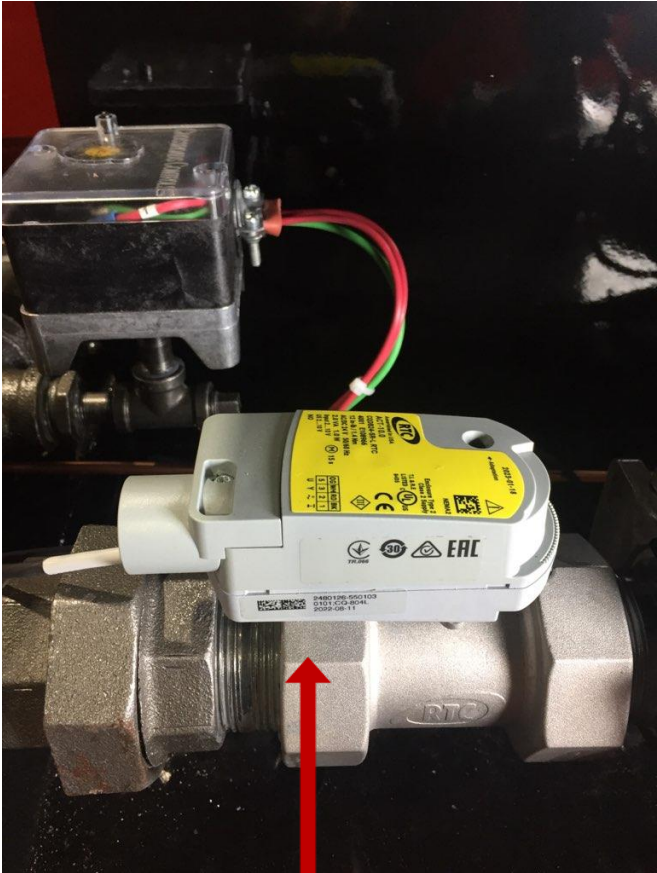

Variable Gas Valve

- Once the pilot flame has been established, the main flame will come on and will begin to modulate as needed to maintain the discharge air temperature at the pre-set temperature, Only if the remote thermostat is connected.
- Back to technical information menu... [Page 23](#)

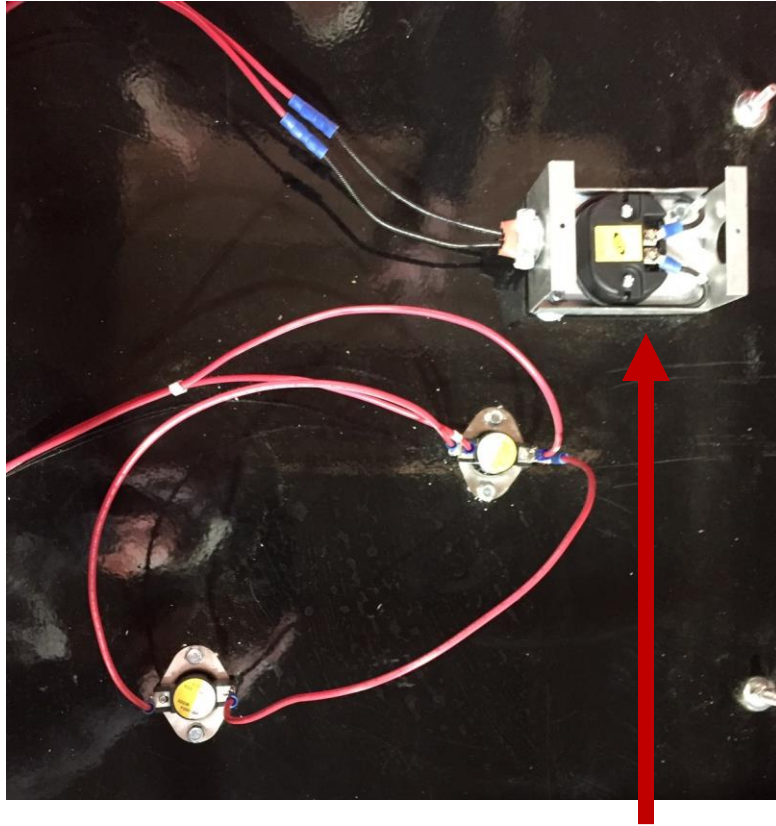

Discharge air temp sensor.

The discharge air temp sensor is mounted in an air mixing tube, located near the discharge air side of the heater. Its function is to provide temperature information to the amplifier (DFC+). This information is used by the amplifier to control the “MAX” air temp portion of the amplifier.

- Back to technical information menu... [Page 23](#)

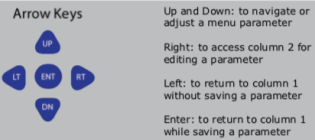
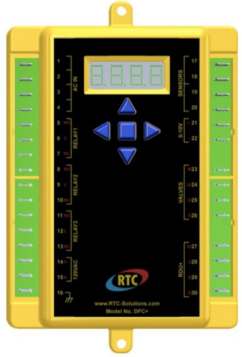

- **Older** Heaters set points...
- The DFC+ will always display the current discharge air temperature. Press any arrow key to change the discharge setpoint temperature. Once an arrow key is pressed, the LED will display the text for the current setpoint temperature. Use the down or up key to set a new discharge temperature, then press the middle key to save the changes made. If a key is not pressed for 10 seconds, the DFC+ will exit without saving. When adjusting the set point range, the set point cannot surpass the set Low and High values. That is **120°F** to **250°F**.
- **Example:** if the Low set point is set to **150°F** the heater will start up and will reach **250°F**. then turn down to **150°F** degrees and maintain the discharge air at **150°F** until the unit is shut down or the discharge air temperature is changed. If the Low setting is not changed the heater will continue to operate at the set range weather, it is shut down or not.
- **Newer** Heaters set points... [Page 33](#)

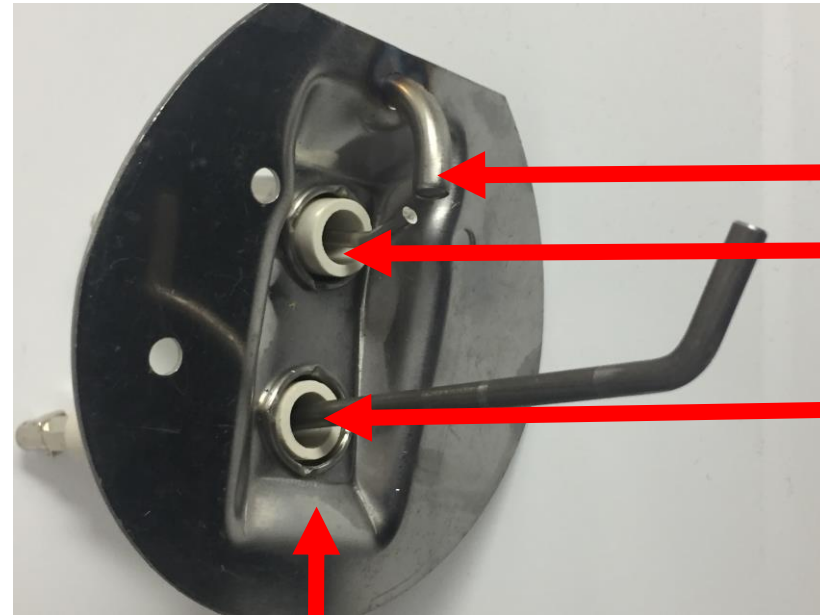

Pilot Gas Burner

Spark Electrode

Flame Rod

Pilot Burner Assembly

➤ Back to technical information menu...[Page 23](#)



- **WARNING:** If the heater is going to be fed with power from a generator, always have the heater unplugged until the generator is running stable. Ensure the generator is sized to accommodate the heater voltage demand.
- The **EB4500DF** power supply must be **480 volts** 63-amp 3 phase only and 240/208 volts 32-amp 3 phase only.
- **Special Note:** The unit is shipped new with the supply voltage set to **480/240 volts**. If the supply voltage is to be **208 volts**, the taps on the 38KVA transformer must be switched from **240 volts** to **208 volts**. See instructions... [Page 56](#)
- Back to technical information menu... [Page 23](#)





➤ **Note:** All gas piping should be calculated and installed by a qualified Gas fitter. Gas fitters have charts for sizing gas pipes and proper regulators for different pressures and installations.

All gas piping should be free from rust and dirt inside the piping. When the heater is not connected to gas piping, ensure all connections are capped to prevent dirt entering the gas train.

➤ **Example** of gas and regulator sizing...[Page 44](#)

➤ Back to technical information menu...[Page 23](#)



Newer Heaters set points...

- The DFC+ will always display the current discharge air temperature. Press any arrow key to change the discharge setpoint temperature. Once an arrow key is pressed, the LED will display the text for the current setpoint temperature. Use the down or up key to set a new discharge temperature, then press the middle key to save the changes made. If a key is not pressed for 10 seconds, the DFC+ will exit without saving. When adjusting the set point range, the set point cannot surpass the set Low and High values. That is **90°F** to **250°F**.
- **Example:** if the Low set point is set to **150°F** the heater will start up and will reach **250°F**. then turn down to **150°F** degrees and maintain the discharge air at **150°F** until the unit is shut down or the discharge air temperature is changed. If the Low setting is not changed the heater will continue to operate at the set range weather, it is shut down or not.

➤ back to technical information menu... [Page 23](#)



DUCTWORK

This heater is designed for use with or without ductwork. Only ductwork specified by the manufacturer shall be used with this heater. Slide duct unto the tapered discharge transition of the heater until fit is tight. Support duct as required. All attached duct should be configured to ensure static pressure at the heater discharge does not exceed .15” WC (.037 kPa).

- Back to technical information menu...[Page 23](#)

Gas Train Components and test ports...

“Field Assist Troubleshooting Guide”



Note... gas pressures are different for Natural gas/propane

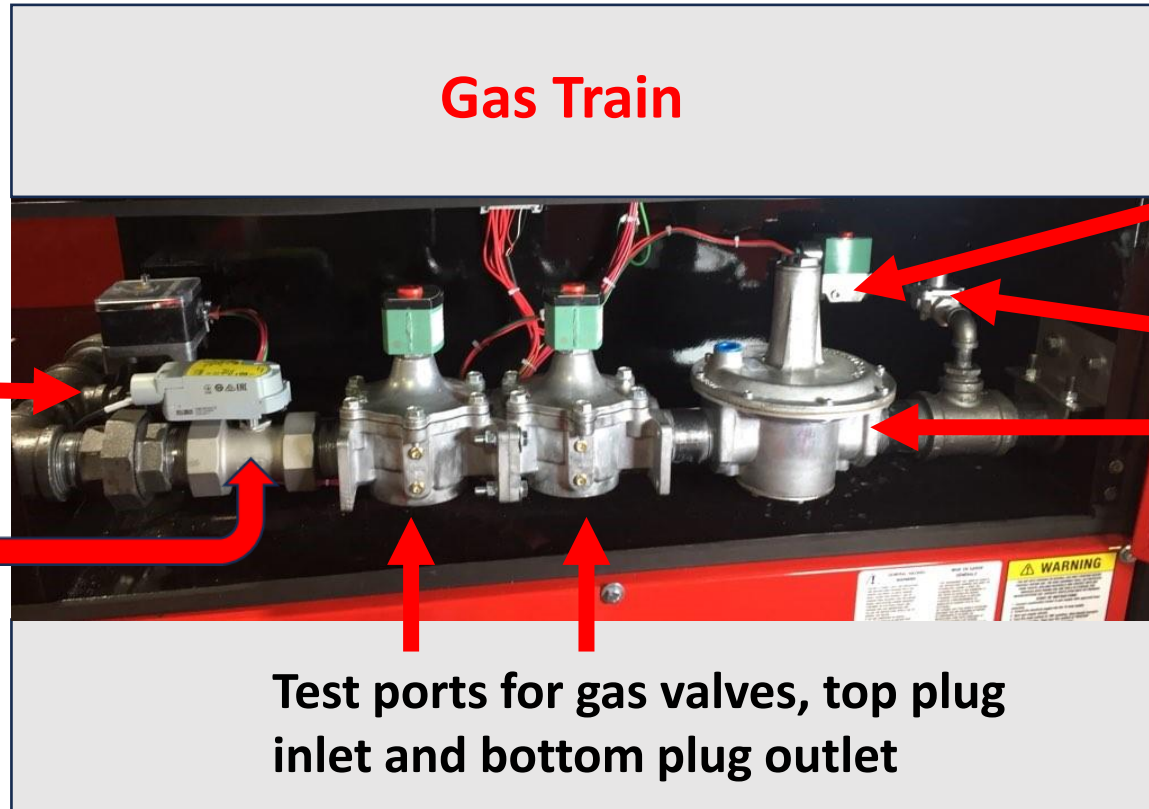

Gas Train

Pilot Gas Valve test port.

Pilot burner gas pressure regulator.

Main burner gas Pressure regulator.

Test ports for gas valves, top plug inlet and bottom plug outlet

Test port for gas to main burner black pipe Tee

Variable Gas Valve

➤ Back to technical information menu... [Page 23](#)



➤ Most important to Check main gas solenoid valves to ensure one of them is not stuck open... Page 37	
Inspect ignition cable for cracks or current leakage	✓ done
Check air switch hose for cracks	✓ done
Clean flame rod and ignition electrode	✓ done
Check wiring terminals inside control panel, tighten if lose	✓ done
Clean blower wheel (remove dust)	✓ done
Clean heater casing and check for dents Note: large dents effect heater performance	✓ done
Start heater and check below items...	✓ done
Gas train fittings for leaks	✓ done
Operation of thermostat /bypass	✓ done
Check and adjust gas pressure if needed	✓ done
Check control safety lock-out	✓ done
Back to technical information menu... Page 23	



Top plug inlet pressure
Bottom plug outlet pressure

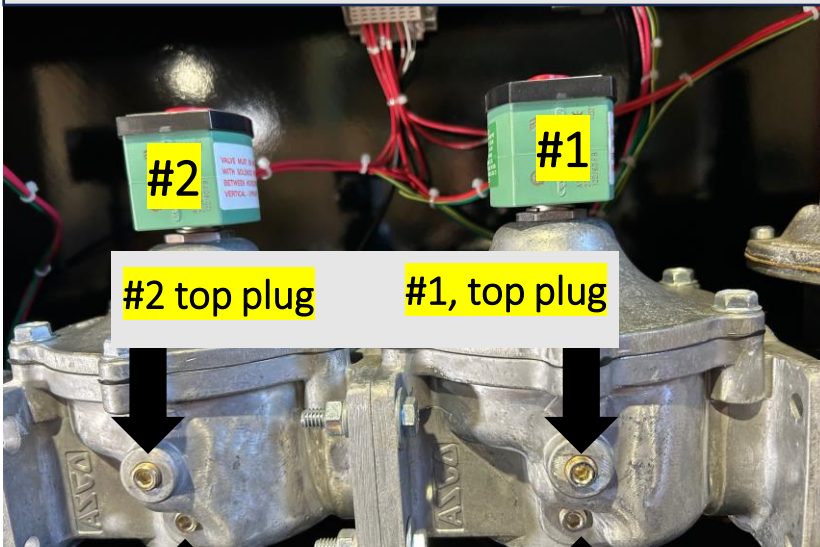

#2 bottom plug

#1 bottom plug

- **Danger:** It is most important to check the gas valves every year to ensure one or both valves are not **stuck open**. Failure to check this can cause a **dangerous** situation.

To test the valves, **unplug** the heater and leave the heater off for the duration of the tests. Connect the heater to gas piping. Turn the gas off. Install your manometer into the test port on valve **#1 bottom plug**. Turn the gas valve on and check if there is pressure. If you have pressure valve **#1** is stuck open, defective. If you have no pressure valve **#1** is good. To test valve **#2**, Shut of the gas and install a hose between valve test port **#1**, top plug and valve **#2 top plug** . Install your manometer on **#2** valve bottom plug. Turn the gas back on. If you now have pressure gas valve **#2** is stuck open, defective.

Back to annual maintenance...[Page 36](#)

Back to technical information menu...[Page 23](#)



Propane main burner pressure **3"** WC

Propane Pilot burner pressure **3.6"** WC

Natural gas main burner **5.6"** WC

Natural gas pilot burner **3.6"** WC

- Back to technical information menu... [Page 23](#)
- Return to start up procedure... [Page 25](#)

Piping charts gas 0.6 specific gravity... “Field Assist Troubleshooting Guide”



1

.05 PSIG. Or less... [Page 40](#)



2

1 PSIG. With less than 10 % pressure drop... [Page 41](#)



3

2 PSIG. With less than 10 % pressure drop... [Page 42](#)



4

5 PSIG. With less than 10 % pressure drop... [Page 43](#)

➤ **Note:** All gas piping should be calculated and installed by a qualified Gas fitter.

Gas fitters have charts for sizing gas pipes and proper regulators for different pressures and installations.

➤ Back to technical information menu... [Page 23](#)

➤ How to size piping and regulators example... [Page 44](#)

**Pipe sizing Table for 0.5 (14" WC) pounds Pressure with a 10% Pressure drop and a gas of...
0.6 Specific Gravity**

Nominal Iron Pipe Size, Inches	Internal Diameter, Inches	Length of Pipe, Feet													
		10	20	30	40	50	60	70	80	90	100	125	150	175	200
¼	.364	32	22	18	15	14	12	11	11	10	9	8	8	7	6
⅜	.493	72	49	40	34	30	27	25	23	22	21	18	17	15	14
½	.622	132	92	73	63	56	50	46	43	40	38	34	31	28	26
¾	.824	278	190	152	130	115	105	96	90	84	79	72	64	59	55
1	1.049	520	350	285	245	215	195	180	170	160	150	130	120	110	100
1¼	1.380	1,050	730	590	500	440	400	370	350	320	305	275	250	225	210
1½	1.610	1,600	1,100	890	760	670	610	560	530	490	460	410	380	350	320
2	2.067	3,050	2,100	1,650	1,450	1,270	1,150	1,050	990	930	870	780	710	650	610
2½	2.469	4,800	3,300	2,700	2,300	2,000	1,850	1,700	1,600	1,500	1,400	1,250	1,130	1,050	980
3	3.068	8,500	5,900	4,700	4,100	3,600	3,250	3,000	2,800	2,600	2,500	2,200	2,000	1,850	1,700
4	4.026	17,500	12,000	9,700	8,300	7,400	6,800	6,200	5,800	5,400	5,100	4,500	4,100	3,800	3,500

**Pipe sizing Table for 1 Psig. Pressure with a 10% Pressure drop and a gas of...
0.6 Specific Gravity**

Schedule 40 Standard Pipe (Inches)	Internal Diameter (Inches)	Total Equivalent Length of Pipe in Feet										
		50	100	150	200	250	300	400	500	1000	1500	2000
1.00	1.049	717	493	396	338	300	272	233	206	142	114	97
HOME 1.25	1.380	1471	1011	812	695	616	558	478	423	291	234	200
1.50	1.610	2204	1515	1217	1041	923	836	716	634	436	350	300
2.00	2.067	4245	2918	2343	2005	1777	1610	1378	1222	840	674	577
2.50	2.469	6766	4651	3735	3196	2833	2567	2197	1947	1338	1075	920
3.00	3.068	11962	8221	6602	5650	5008	4538	3884	3442	2366	1900	1626
3.50	3.548	17514	12037	9666	8273	7332	6644	5686	5039	3464	2781	2381
4.00	4.026	24398	16769	13466	11525	10214	9255	7921	7020	4825	3875	3316
5.00	5.047	44140	30337	24362	20851	18479	16744	14330	12701	8729	7010	6000
6.00	6.065	71473	49123	39447	33762	29923	27112	23204	20566	14135	11351	9715
8.00	7.981	146849	100929	81049	69368	61479	55705	47676	42254	29041	23321	19960
10.00	10.020	266718	183314	147207	125990	111663	101175	86592	76745	52747	42357	36252
12.00	11.938	422248	290209	233048	199459	176777	160172	137087	121498	83505	67057	57392

**Pipe sizing Table for 2 Psig. Pressure with a 10% Pressure drop and a gas of...
0.6 Specific Gravity**

Pipe Size of Schedule 40 Standard Pipe (Inches)	Internal Diameter (Inches)	Total Equivalent Length of Pipe in Feet										
		50	100	150	200	250	300	400	500	1000	1500	2000
1.00	1.049	1112	764	614	525	466	422	361	320	220	177	151
1.25	1.380	2283	1569	1260	1079	956	866	741	657	452	363	310
1.50	1.610	3421	2351	1888	1616	1432	1298	1111	984	677	543	465
2.00	2.067	6589	4528	3636	3112	2758	2499	2139	1896	1303	1046	896
2.50	2.469	10501	7217	5796	4961	4396	3983	3409	3022	2077	1668	1427
3.00	3.068	18564	12759	10246	8769	7772	7042	6027	5342	3671	2948	2523
3.50	3.548	27181	18681	15002	12840	11379	10311	8825	7821	5375	4317	3694
4.00	4.026	37865	26025	20899	17887	15853	14364	12293	10895	7488	6013	5147
5.00	5.047	68504	47082	37809	32359	28680	25986	22240	19711	13547	10879	9311
6.00	6.065	110924	76237	61221	52397	46439	42077	36012	31917	21936	17616	15077
8.00	7.981	227906	156638	125786	107657	95414	86452	73992	65578	45071	36194	30977

**Pipe sizing Table for 5 Psig. Pressure with a 10% Pressure drop and a gas of...
0.6 Specific Gravity**

Pipe Size of Schedule 40 Standard Pipe (Inches)	Internal Diameter (Inches)	Total Equivalent Length of Pipe in Feet										
		50	100	150	200	250	300	400	500	1000	1500	2000
1.00	1.049	1989	1367	1098	940	833	755	646	572	393	316	270
1.25	1.380	4084	2807	2254	1929	1710	1549	1326	1175	808	649	555
1.50	1.610	6120	4206	3378	2891	2562	2321	1987	1761	1210	972	832
2.00	2.067	11786	8104	6505	5567	4934	4471	3827	3391	2331	1872	1602
2.50	2.469	18785	12914	10368	8874	7865	7126	6099	5405	3715	2983	2553
3.00	3.068	33209	22824	18329	15687	13903	12597	10782	9556	6568	5274	4514
3.50	3.548	48623	33418	26836	22968	20356	18444	15786	13991	9616	7722	6609
4.00	4.026	67736	46555	37385	31997	28358	25694	21991	19490	13396	10757	9207
5.00	5.047	122544	84224	67635	57887	51304	46485	39785	35261	24235	19461	16656
6.00	6.065	198427	136378	109516	93732	83073	75270	64421	57095	39241	31512	26970

Natural Gas and Propane Regulator Examples...



1. Obtain the specifications included with the operational instructions for gas heaters.
2. Size the gas regulator according to the gas **inlet** pressure available to the heater.
3. Read the **outlet** pressure required for the heater on the heater specification sheet.
4. Size the regulator according to both the **inlet** and **outlet** gas pipe diameter of the gas train.

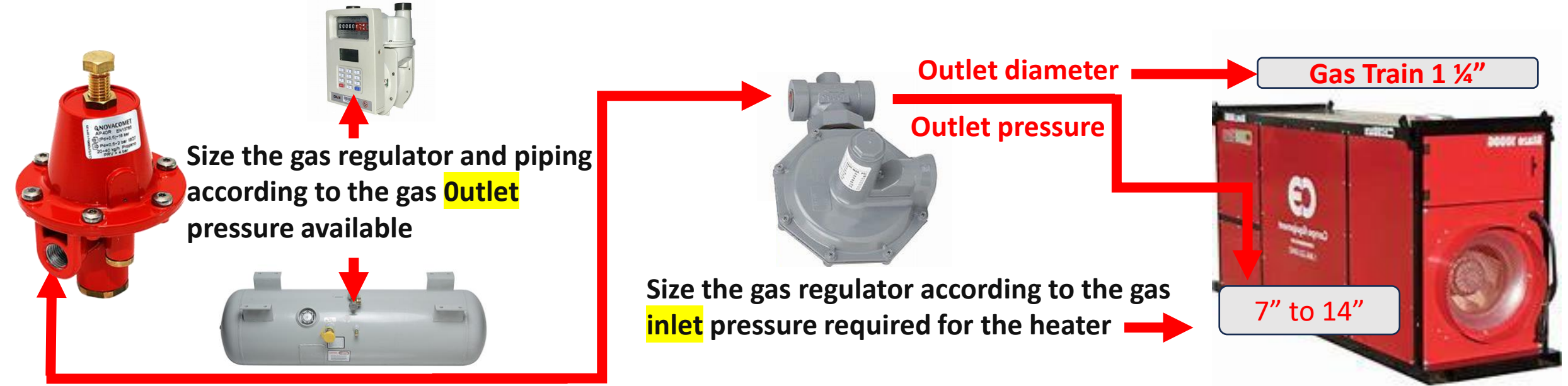

➤ **Note:** The supplied **pressure regulator** with the heater on the gas train is used only to adjust the burner operating pressure. The only time a secondary regulator is not used is when the gas supplied on site from the meter is less than **14"** WC.

Job sizing example... [Page 45](#)

Pipe sizing...

"Field Assist Troubleshooting Guide"



➤ WHAT YOU NEED TO KNOW

What Pressure is available **2 Psig**

Gas type, **Natural Gas**

Total BTUs of all units connected to gas piping **3 million**

Length of longest run. **125 feet**

Natural Gas												
GAS: NATURAL												
INLET PRESSURE: LESS THAN 2 psi												
PRESSURE DROP: 0.5 in. w.c.												
SPECIFIC GRAVITY: 0.60												
PIPE SIZE (inch)												
NORMAL	1/2	3/4	1	1 1/4	1 1/2	2	2 1/2	3	4	6	8	12
ACTUAL I.D.	0.822	0.824	1.049	1.380	1.610	2.067	2.469	3.068	4.026	5.047	6.065	7.981
LENGTH (feet)	CAPACITY IN CUBIC FEET OF GAS PER HOUR											
10	172	360	678	1390	2090	4020	6400	11300	23100	41800	67600	139000
20	118	247	466	957	1430	2760	4400	7780	15900	28700	46500	95000
30	95	199	374	768	1150	2220	3530	6250	12700	23000	37300	76700
40	81	170	320	657	985	1900	3020	5350	10900	19700	31900	65600
50	72	151	284	583	873	1680	2680	4740	9660	17500	28300	58200
60	65	137	257	528	791	1520	2430	4290	8760	15800	25600	52700
70	60	126	237	486	728	1400	2230	3950	8050	14600	23600	48500
80	56	117	220	452	677	1300	2080	3670	7490	13600	22000	45100
90	52	110	207	424	635	1220	1950	3450	7030	12700	20600	42300
100	50	104	195	400	600	1160	1840	3260	6640	12000	19500	40000
125	44	92	173	355	532	1020	1630	2890	5890	10600	17200	35400
150	40	83	157	322	482	928	1480	2610	5330	9650	15600	32100
175	37	77	144	296	443	854	1360	2410	4910	8880	14400	29500
200	34	71	134	275	412	794	1270	2240	4560	8260	13400	27500
250	30	63	119	244	366	704	1120	1990	4050	7320	11900	24300
300	27	57	108	221	331	638	1020	1800	3670	6630	10700	22100



2 million BTU

?

20 feet



1 million BTU

10 feet

Find size of pipe to the first branch using your 2 Psig chart for NG.

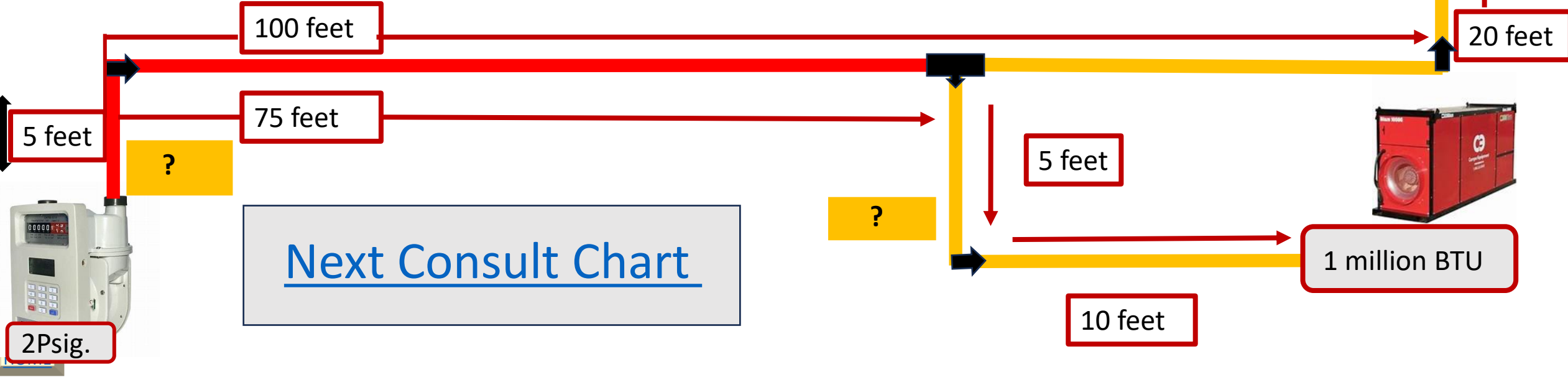

Next Consult Chart

**Pipe sizing Table for 2 pounds Pressure with a 10% Pressure drop and a gas of...
0.6 Specific Gravity**

Pipe Size of Schedule 40 Standard Pipe (Inches)	Internal Diameter (Inches)	Total Equivalent Length of Pipe in Feet										
		50	100	150	200	250	300	400	500	1000	1500	2000
1.00	1.049	1112	764	614	525	466	422	361	320	220	177	151
1.25	1.380	2283	1569	1260	1079	956	866	741	657	452	363	310
1.50	1.610	3421	2351	1888	1616	1432	1298	1111	984	677	543	465
2.00	2.067	6589	4528	3636	3112	2758	2499	2139	1896	1303	1046	896
2.50	2.469	10501	7217	5796	4961	4396	3983	3409	3022	2077	1668	1427
3.00	3.068	18564	12759	10246	8769	7772	7042	6027	5342	3671	2948	2523
3.50	3.548	27181	18681	15002	12840	11379	10311	8825	7821	5375	4317	3694
4.00	4.026	37865	26025	20899	17887	15853	14364	12293	10895	7488	6013	5147
5.00	5.047	68504	47082	37809	32359	28680	25986	22240	19711	13547	10879	9311
6.00	6.065	110924	76237	61221	52397	46439	42077	36012	31917	21936	17616	15077
8.00	7.981	227906	156638	125786	107657	95414	86452	73992	65578	45071	36194	30977

[Next...Page 48](#)

Pipe sizing...



Now you know a 2" is required from the meter to first branch

Next find out the size of the pipe on unit after the branch always using the total feet from the meter to that heater (125 feet)

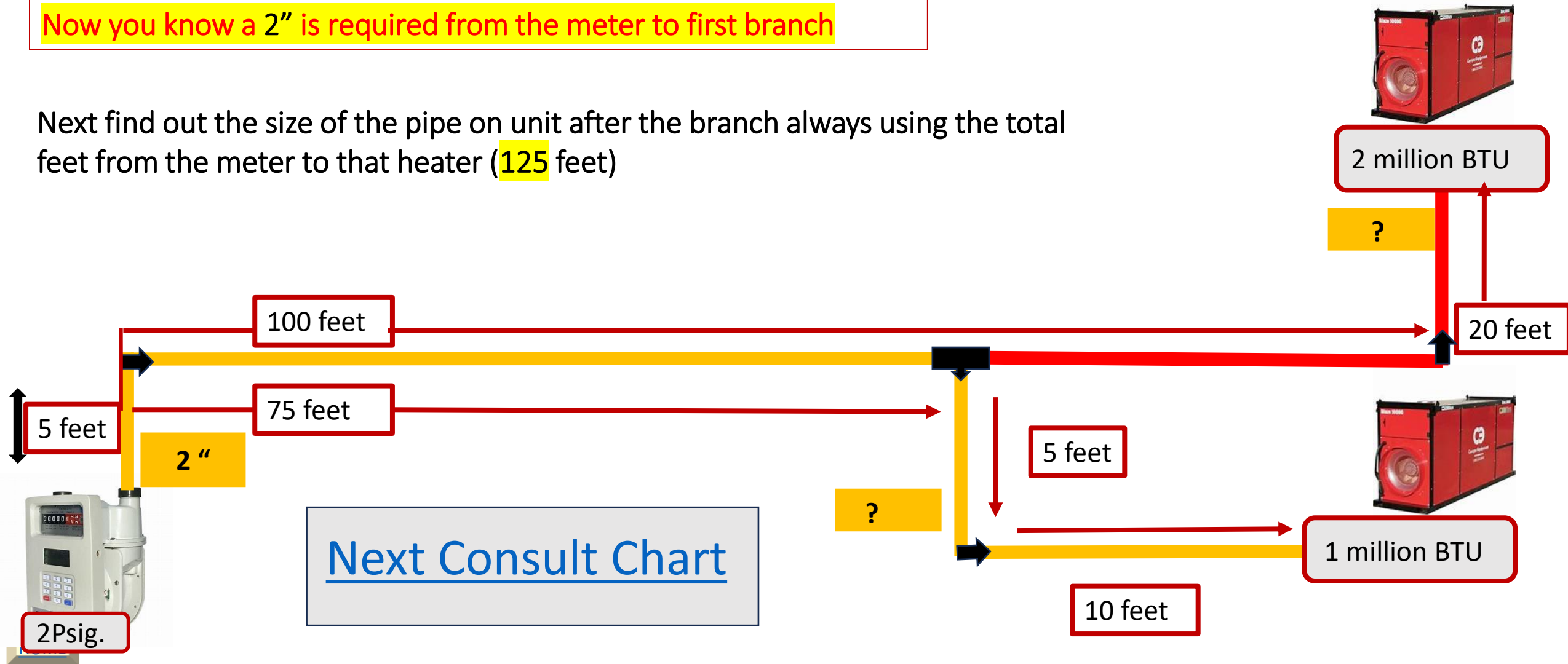

**Pipe sizing Table for 2 pounds Pressure with a 10% Pressure drop and a gas of...
0.6 Specific Gravity**

Pipe Size of Schedule 40 Standard Pipe (Inches)	Internal Diameter (Inches)	Total Equivalent Length of Pipe in Feet										
		50	100	150	200	250	300	400	500	1000	1500	2000
1.00	1.049	1112	764	614	525	466	422	361	320	220	177	151
1.25	1.380	2283	1569	1260	1079	956	866	741	657	452	363	310
1.50	1.610	3421	2351	1888	1616	1432	1298	1111	984	677	543	465
2.00	2.067	6589	4528	3636	3112	2758	2499	2139	1896	1303	1046	896
2.50	2.469	10501	7217	5796	4961	4396	3983	3409	3022	2077	1668	1427
3.00	3.068	18564	12759	10246	8769	7772	7042	6027	5342	3671	2948	2523
3.50	3.548	27181	18681	15002	12840	11379	10311	8825	7821	5375	4317	3694
4.00	4.026	37865	26025	20899	17887	15853	14364	12293	10895	7488	6013	5147
5.00	5.047	68504	47082	37809	32359	28680	25986	22240	19711	13547	10879	9311
6.00	6.065	110924	76237	61221	52397	46439	42077	36012	31917	21936	17616	15077
8.00	7.981	227906	156638	125786	107657	95414	86452	73992	65578	45071	36194	30977

[Next](#)

Pipe sizing...



1. Natural Gas chart 2Psig.
2. Total BTUs of all units connected Branch **1 Million BTUs**
3. Total Length of Branch = **95 feet**

Next find out the size of the pipe on the branch using the total feet from the meter to that unit run (**95 feet**) and the total BTUs on that branch

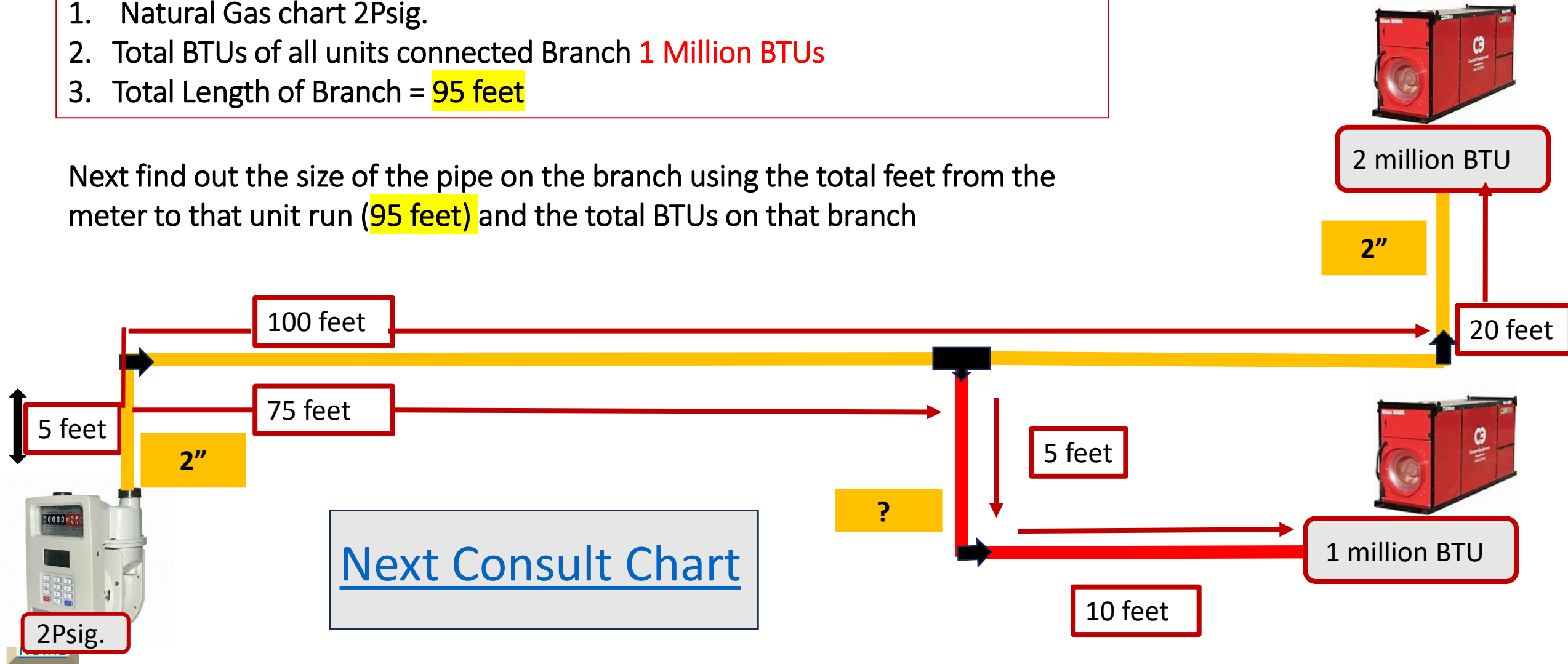

**Pipe sizing Table for 2 pounds Pressure with a 10% Pressure drop and a gas of...
0.6 Specific Gravity.**

Pipe Size of Schedule 40 Standard Pipe (Inches)	Internal Diameter (Inches)	Total Equivalent Length of Pipe in Feet										
		50	100	150	200	250	300	400	500	1000	1500	2000
1.00	1.049	1112	764	614	525	466	422	361	320	220	177	151
1.25	1.380	2283	1569	1260	1079	956	866	741	657	452	363	310
1.50	1.610	3421	2351	1888	1616	1432	1298	1111	984	677	543	465
2.00	2.067	6589	4528	3636	3112	2758	2499	2139	1896	1303	1046	896
2.50	2.469	10501	7217	5796	4961	4396	3983	3409	3022	2077	1668	1427
3.00	3.068	18564	12759	10246	8769	7772	7042	6027	5342	3671	2948	2523
3.50	3.548	27181	18681	15002	12840	11379	10311	8825	7821	5375	4317	3694
4.00	4.026	37865	26025	20899	17887	15853	14364	12293	10895	7488	6013	5147
5.00	5.047	68504	47082	37809	32359	28680	25986	22240	19711	13547	10879	9311
6.00	6.065	110924	76237	61221	52397	46439	42077	36012	31917	21936	17616	15077
8.00	7.981	227906	156638	125786	107657	95414	86452	73992	65578	45071	36194	30977
10.00	10.020	413937	284497	228461	195533	173297	157020	134389	119106	81861	65737	56263

[Next](#)



Piping for job complete

- Steve's Job site requiring 1 heater - 1 million BTUs and 1 - heater 2 million BTUs.

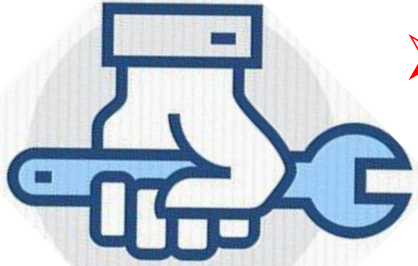

2 million BTU

2"

20 feet



1 million BTU

5 feet

1 1/4"

10 feet

100 feet

75 feet

2"

Multiple units on a header

5 feet

2Psig.



Pipe sizing multiple heaters one header...



Note: any other appliances operating off the same meter would have to be calculated in to piping.

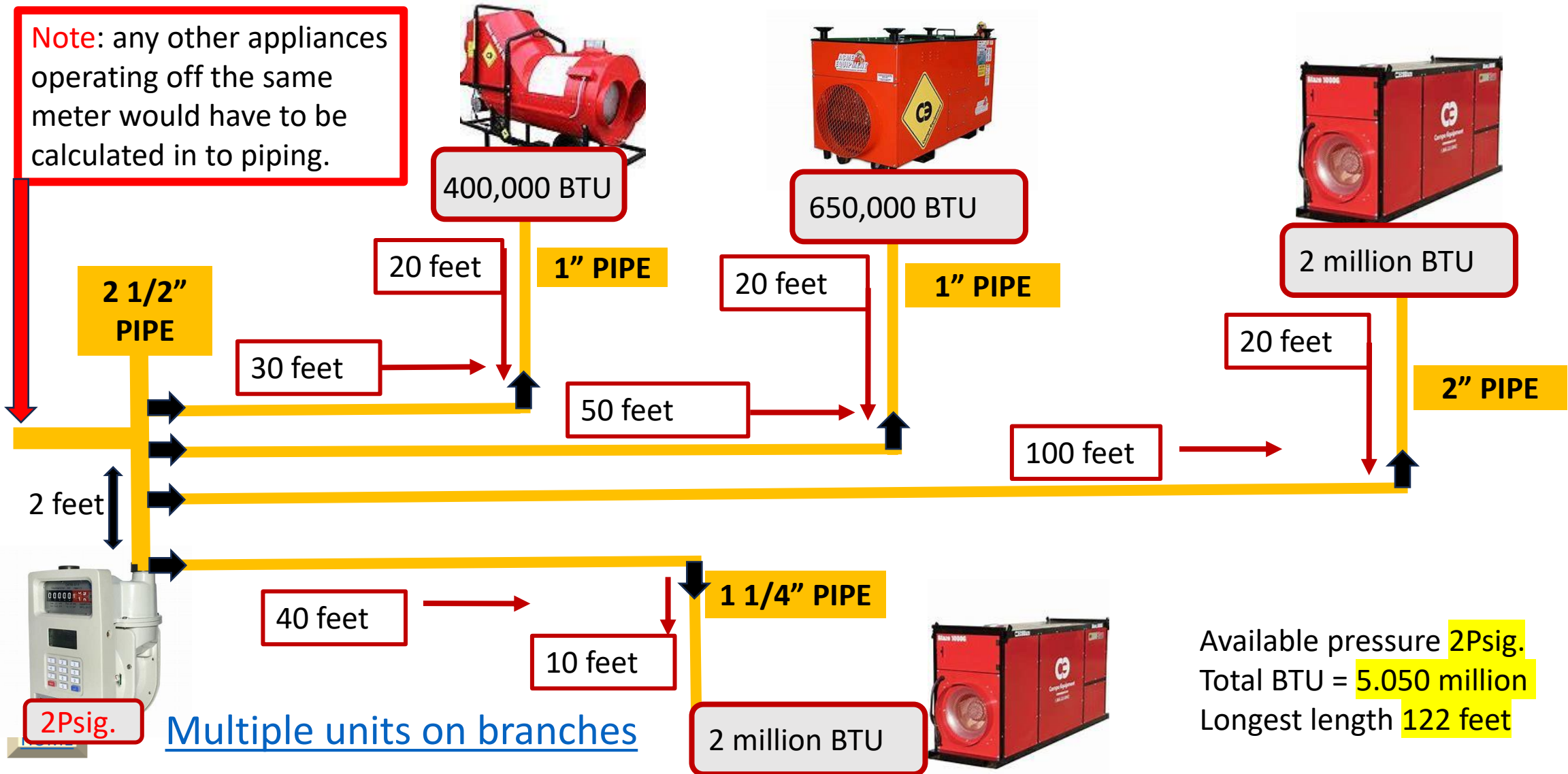

Available pressure 2Psig.
Total BTU = 5.050 million
Longest length 122 feet

Gas pressure Comparisons...

"Field Assist Troubleshooting Guide"



If you had Available pressure **0.5Psig. = (14" WC)**
Total BTUs 3 million. Longest length = 125 feet
3" inch pipe needed

- 1. Available pressure **2Psig.**
- 2. Total BTU = **3000,000**
- 3. Longest length = **125 feet**
2" inch pipe needed

If you had Available pressure **5Psig.**
Total BTU = **3000,000**
Longest length = 125 feet
1 1/4" pipe needed



2 million BTU

2"

20 feet



1 million BTU

10 feet

1 1/4"

5 feet

100 feet

75 feet

5 feet

2"



2Psig.

Note: any other **EXISTING** appliances operating off the same meter would have to be calculated in to piping.

➤ Back to technical information menu... [Page 23](#)

Switching from 240 volts to 208 volts “Field Assist Troubleshooting Guide”



Ensure the **power** to the heater is **shut off**.

Start by removing the top cover of the heater to access the 38KVA transformer.

Change the connections from **240 volts** X1-X2-X3 to **208 volts** X4-X5-X6

Top cover of the heater



38KVA transformer

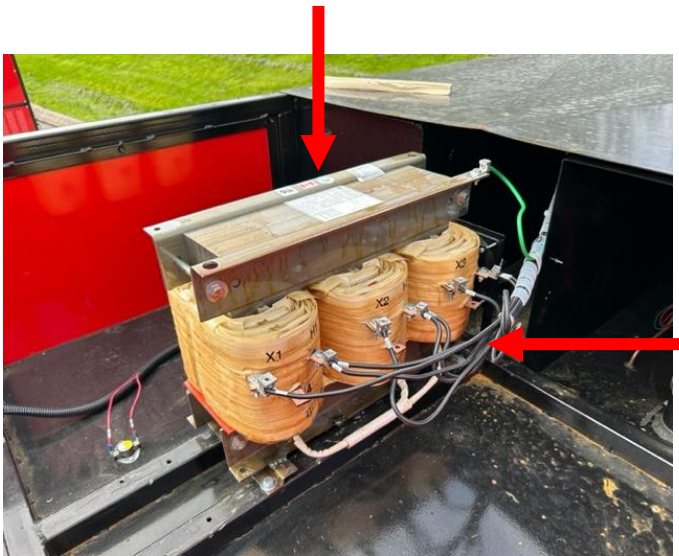

Taps Connections

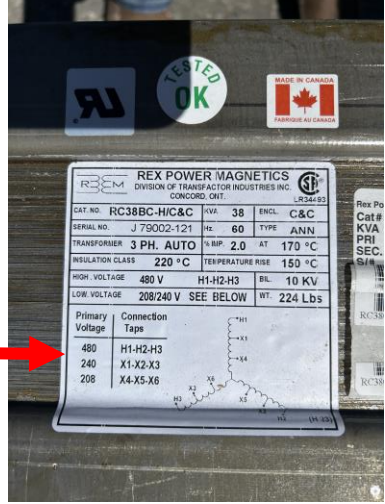

Note: This should be done by a qualified electrician.



Welcome to the Campo “Field Assist Troubleshooting Guides”.

These guides were developed to assist the working technicians in the field. We’ve supplied issues and solutions to the most common problems encountered in the field. If you need assistance while troubleshooting on the job, they are easy to store in your smart phone, tablet or computer.

Getting Started is easy! Just click on [Page #](#) for the problem you are encountering

➤ If your voltage is **480 volts**

➤ **The** blower fan starts, but the control is **locked-out alarm**... [Page 2](#)

➤ **The** blower fan starts, and the burner control is **NOT locked-out**...[Page 7](#)

➤ **No heat** and the blower fan won't start...[Page 58](#)

➤ **The** blower fan won't stop automatically after call for heat is satisfied...[Page 17](#)

➤ **The ‘overheat reset’** light is illuminated and will not reset...[Page 18](#)

➤ **The** burner doesn't modulate...[Page 19](#)

➤ **Technical** information and more... [Page 23](#)

No heat and the blower fan doesn't start...



➤ If the supply voltage is **480 volts**

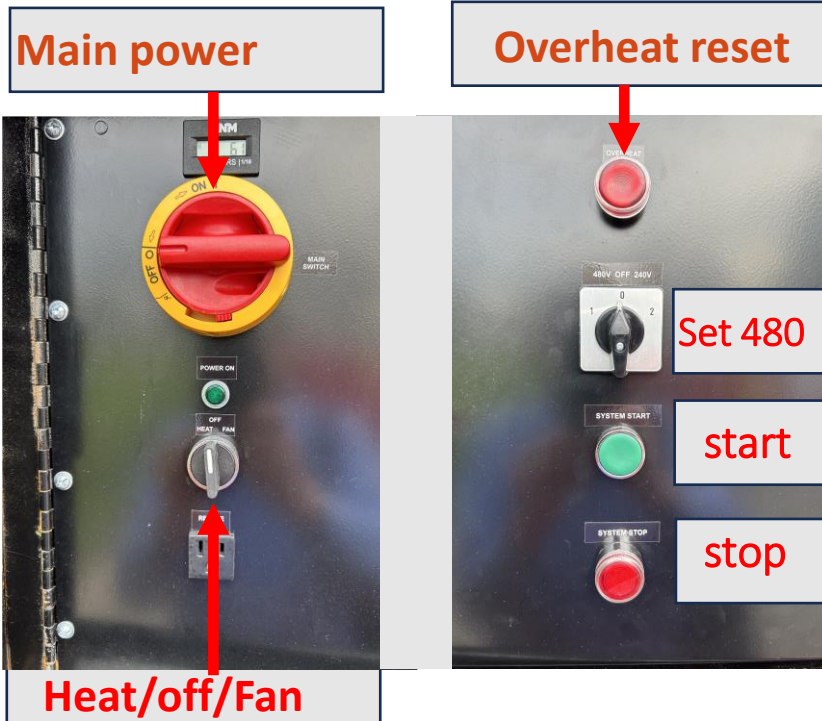

- Ensure the **240/480 selector switch** is set to **480 volts**.
- Tie wrap the voltage selector switch to selected voltage to ensure no error in made during heater operation.
- Ensure the main power switch is **on**.
- Ensure the Heat/off/Fan switch is **turned to Heat**.
- Ensure the overheat switch is **not** off on reset.
- Ensure the start button is pushed in.

➤ Continue... [Page 59](#)

No heat and the blower fan doesn't start...

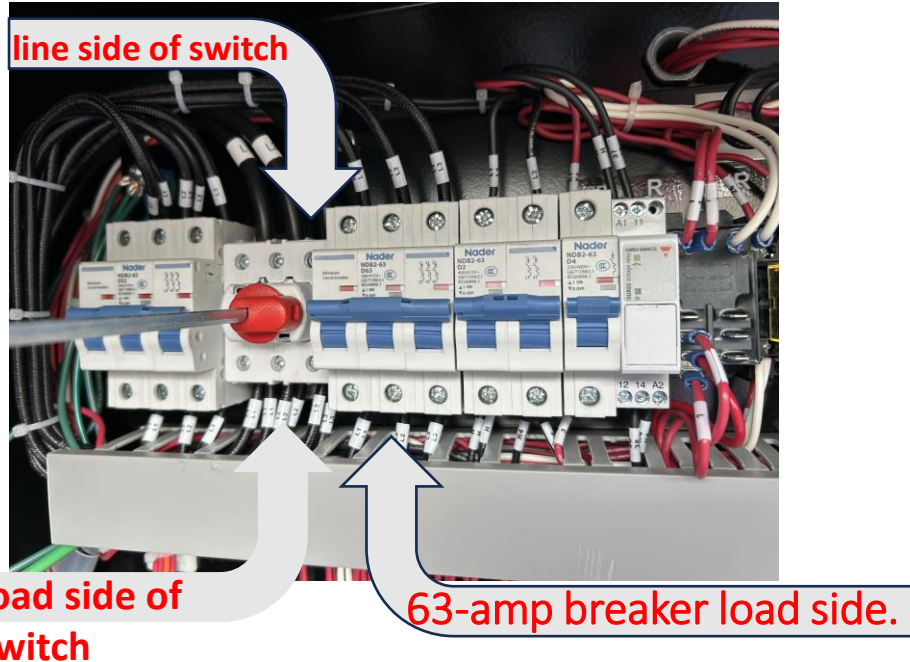

- Before Proceeding, It is **important** to check voltage from phase to phase "**Not**" to ground. **Note**: the DF4500 is **3 phase** only.
- Check for **480 volts** on main switch, line side.
- ✓ If **480 volts** is **not** present, issue with power supply.
- If **480 volts** is present, check for **480 volts** on load side of switch.
- ✓ If **480 volts** is **not** present, defective switch.
- If **480 volts** is present, check for **480 volts** on **32-amp breaker** load side.
- ✓ If **480 volts** is **not** present, defective breaker or tripped off.
- If **480 volts** is present continue...[Page 60](#)

No heat and the blower fan doesn't start...



#1 and #2 on terminal

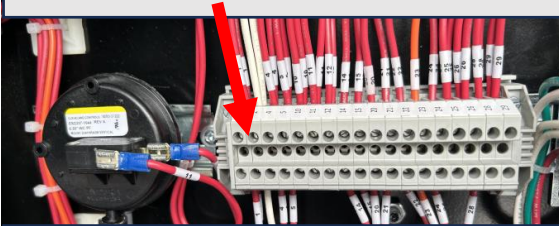

240/208 volts primary
H3-H4

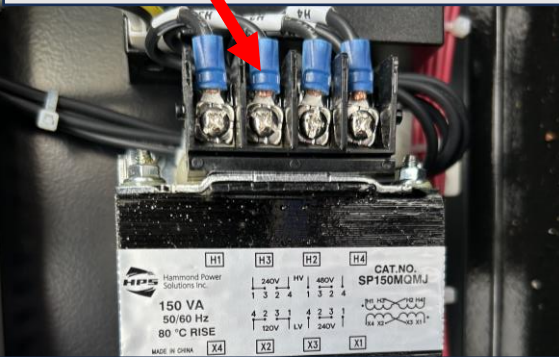

120 volts on secondary



- Check for **120 volts** between #1 and #2 on terminal block.
- If **120 volts** is **not** present, check for **120 volts** on the red and white wire of the secondary of **150 VA** transformer.
- If **120 volts** is present...[Page 62](#)
- If **120 volts** is **not** present, check for **480 volts** on primary of transformer **H1** and **H4**.
- ✓ If **480 volts** is present, defective transformer.
- If **480 volts** is **not** present...[Page 61](#)

No heat and the blower fan doesn't start...



VR.

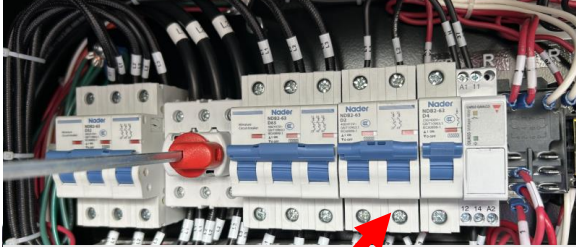

2-amp breaker
Transfer switch

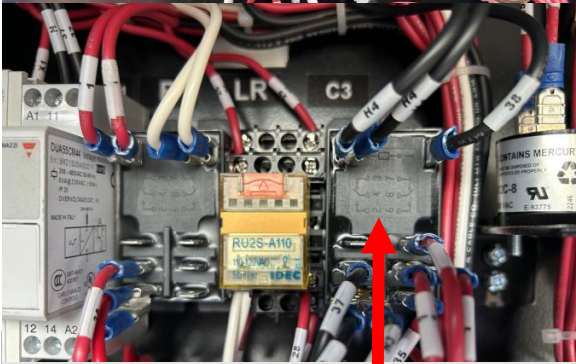
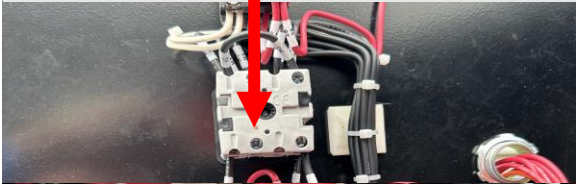

C3 contact

- If 480 volts is not present, Check 2-amp breaker. If the breaker is not tripped, check for 480 volts on the load side of the breaker H1 and H4.
- ✓ If 480 volts is not present, defective breaker.
- ✓ If 480 volts is present, defective voltage selector switch.

➤ Problem solved

No heat and the blower fan doesn't start...



4-amp breaker



Start switch

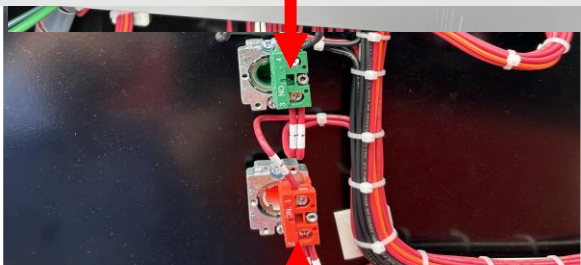

Stop switch

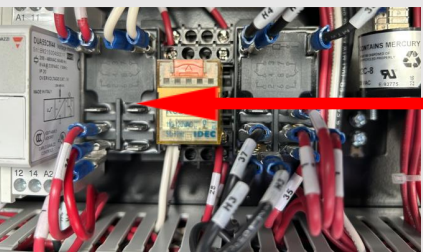

R-Relay

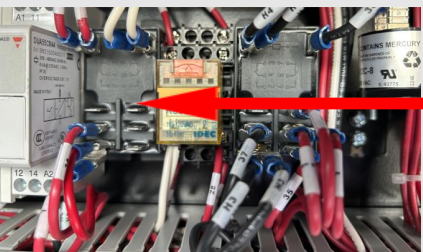

- Check for 120 volts on wire #3 on 4-amp breaker.
- ✓ If 120 volts is not present, tripped breaker or defective.
- If 120 volts is present, check for 120 volts on wire #3A on stop switch.
- ✓ If 120 volts is not present, defective stop switch.
- If 120 volts is present, press and hold the start switch in and check for 120 volts on wire #1 on start switch while holding it in.
- ✓ If 120 volts is not present, defective start switch.
- ✓ If 120 volts is present, and the unit starts and shuts down when you release the start button, defective R relay.
- If 120 volts is present, and the unit doesn't start check for 120 volts on wire #33 on C3 contact.
- ✓ If 120 volts is not present, defective C3 contact.
- If 120 volts is present, check for 120 volts on wire #34 on C1 coil.
- ✓ If 120 volts is not present, defective C2 contact.
- If 120 volts is present, [Page 15](#)